

- Grand Digital Piano
- **GDP-6320**

User's Manual

## Precaution

Thank you for purchasing this digital instrument. For correct use, please read the manual carefully and keep it for future reference.

### Safety Precautions

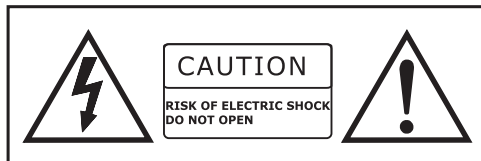

The lightning flash with arrowhead symbol within an equilateral triangle is intended to alert the user to the presence of uninsulated “dangerous voltage” Within the product’s enclosure that may be of sufficient magnitude to constitute a risk of electric shock to persons.



The exclamation point within an equilateral triangle is intended to alert the user to the presence of important operating and maintenance (servicing) instructions in the literature accompanying the product.

### Important Safety Instructions



(Figure 1)

- 1) Read these instructions.
  - 2) Keep these instructions.
  - 3) Heed all warnings.
  - 4) Follow all instructions.
  - 5) Do not use this apparatus near water.
  - 6) Clean only with dry cloth.
  - 7) Do not block any ventilation openings, and install in accordance with the manufacturer's instructions.
  - 8) Do not install near any heat sources such as radiators, heat registers, stoves, or other apparatus (including amplifiers) that produce heat.
  - 9) Do not defeat the safety purpose of the polarized or grounding-type plug. A polarized plug has two blades with one wider than the other. A grounding type plug has two blades and a third grounding prong. The wide blade or the third prong is provided for your safety. If the provided plug does not fit into your outlet, consult an electrician for replacement of the obsolete outlet.
  - 10) Protect the power cord from being walked on or pinched particularly at plugs, convenience receptacles, and the point where they exit from the apparatus.
  - 11) Only use attachments/accessories specified by the manufacturer.
  - 12) Use only with the cart, stand, tripod, bracket, or table specified by the manufacturer or sold with the apparatus. When a cart is used, use caution when moving the cart/apparatus combination to avoid injury from tip-over (Figure 1) .
  - 13) Unplug this apparatus during lightning storms or when unused over a long period of time.
  - 14) Refer all servicing to qualified service personnel. Servicing is required when the apparatus has been damaged in any way, such as power-supply cord or plug is damaged, liquid has been spilled or objects have fallen into the apparatus, the apparatus has been exposed to rain or moisture, does not operate normally, or has been dropped.
- WARNING:** To reduce the risk of fire or electric shock, do not expose this apparatus to rain or moisture.
- CAUTION:** Apparatus shall not be exposed to dripping or splashing and no objects filled with liquids, such as vases, shall be placed on the apparatus.

## **Thanks for Using Our digital piano**

Your digital piano is a high-quality digital piano with 88 standard touch sensitivity keyboard and combines the most advanced PCM tone generation technology. This digital piano lets you record your performances and Registration settings to a USB Disk. Each user song lets you record up to sixteen independent tracks. In order to obtain maximum performance and enjoyment, please read this manual thoroughly while trying out the various features described.

# Contents

<b>Panel Control</b> .....	<b>1</b>
<b>Set Up</b> .....	<b>3</b>
<b>Basic Operation</b> .....	<b>4</b>
Standby/On .....	4
Foot Pedals .....	4
Adjust the Volume .....	6
Adjust the Sound .....	6
Demo Play .....	6
<b>The Connector Box</b> .....	<b>8</b>
Headphones .....	8
MIDI OUT .....	8
Line OUT .....	9
Using USB-MIDI .....	9
Aux In .....	10
Blue tooth .....	10
<b>Voices</b> .....	<b>11</b>
Selecting a Voice .....	11
Setting a Voice .....	11
Group Function .....	12
Dual Mode .....	12
Split Mode .....	13
Adjusting Keyboard Volume .....	14
<b>Effect</b> .....	<b>16</b>
Reverb .....	16
Chorus .....	17
Touch .....	17
Transpose .....	18
Tempo .....	19
Metronome .....	19
Twin Mode .....	20
<b>Function</b> .....	<b>21</b>
<b>Registration Memory</b> .....	<b>38</b>
Store .....	38
Load .....	38
Saving Registration Data to USB Disk .....	39
Read Registration Data From USB Disk .....	39
Delete REG File From USB .....	40
<b>Recording</b> .....	<b>41</b>
Quick Recording .....	41
Multi Track Recording .....	42
MelodyTrack Recording .....	44
Saving the Recording to USB Disk .....	45
Load MIDI File .....	45
Delete Song .....	46
USB Memory Button .....	46
Mute Track .....	47
Adjust the Song's volume .....	47
<b>Teaching Function</b> .....	<b>48</b>
Selecting a Song .....	48
Listening to the Entire Song .....	48
Practicing the Right Hand of the Selected Song .....	48
Practicing the Left Hand of the Selected Song .....	49
Practicing the Both Hands of the Selected Song .....	49
<b>Bluetooth</b> .....	<b>50</b>
Bluetooth Connection .....	50
<b>MIDI Function</b> .....	<b>52</b>
MIDI In .....	52
MIDI Out Track .....	52
Local On/Off .....	52
<b>Factory Reset</b> .....	<b>53</b>
<b>Appendix</b> .....	<b>54</b>
Percussion Voice List .....	54
Voice List .....	55
MIDI Implementation Chart .....	57
Troubleshooting Hints .....	58
Specifications .....	59
Assembly Instructions .....	60



# Panel Control

## Top Panel

1. STANDBY/ON
2. MASTER VOLUME fader
3. BRIGHTNESS fader
4. MULTI DISPLAY
5. [RECORD] button
6. [TRACK1/LEFT] button
7. [TRACK2/RIGHT] button
8. [PLAY] button
9. [USB MEMORY] button
10. [LEARN] button
11. [REVERB] button
12. [CHORUS] button
13. [METRONOME] button
14. [DEMO] button
15. [FUNCTION] button
16. [TEMPO] button
17. [TRANS.] button
18. VOICE SELECT  
REGISTER MEMORY  
[M1]~[M8] button  
[BANK/LOAD] button
19. [USER/STORE] button
20. [SPLIT] button
21. [DUAL] button
22. [TWIN] button
23. [KBD.VOL] button
24. [TOUCH] button
25. USB TO DEVICE Jack

## Interface Panel

26. HEADPHONES1/2 Jacks
27. MIDI OUT Jacks
28. USB TO HOST Jack
29. Bluetooth Jack
30. AUX IN Jacks
31. LINE OUT Jacks
32. Input Level
33. PEDAL
34. AC POWER



# Set Up

You are no doubt eager to play your piano, but first please make sure you have completed the following basic setup steps:

- 1) Follow the assembly instructions as outlined on page 58 in the appendix of this manual.
- 2) Once the piano is securely assembled, connect the plug of the foot pedal unit to the pedal jack on the rear panel.

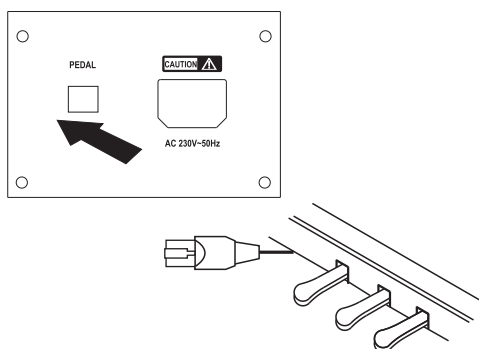

- 3) Plug in the included power chord to the bottom of the piano body as illustrated below. Position the piano in the desired location, making sure that the power chord can reach a AC power connection point.

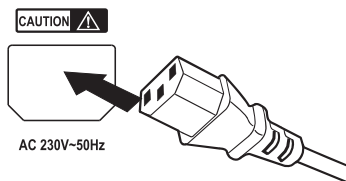

- 4) Then plug the other end of the power cable into the AC power outlet.

## **NOTE**

1. Ensure the piano is turned off when connecting and disconnecting the power.
2. Turn the volume knob to its minimum level before turning on the power.

# Basic Operation

## Standby/On

Press the [STANDBY/ON] button to turn on the power and the LCD display will light.



## Auto Standby

Your piano will switch off automatically in 30 minutes after no any operation on it. In this case, press the [STANDBY/ON] button again to turn on the power.

### NOTE

When you are playing the Demo song, it will not switch off automatically in 30 minutes after no any operation on it.

## Deactivate Auto Standby Function

Hold the first white key and first black key on the left side of the keyboard at the same time and then press the [STANDBY/ON] button to deactivate the Auto Standby function. (Reference: Auto Power off time P37)

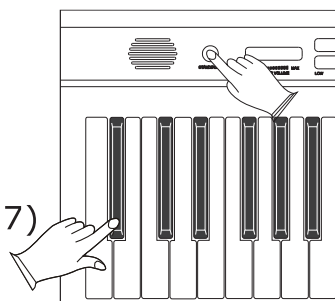

## Foot Pedals

Connect the plug of the foot pedal unit to the pedal jack in the bottom panel.

PEDAL

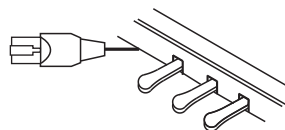

## **Damper Pedal (Right)**

It performs the same function as the damper pedal on an actual acoustic piano, letting you sustain the sound of the voices even after releasing your fingers from the keys. Your piano has Half-pedal function. You may release your foot from the pedal to different position to change the sustain time. The less you release your foot from the pedal, the longer the sustain effect lasts.

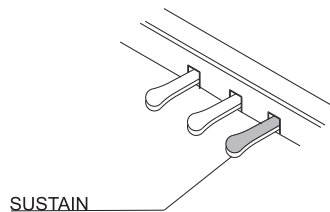

## **Sostenuto Pedal (Center)**

If you play a note or chord on the keyboard and press the sostenuto pedal while the notes are held, those notes will be sustained as long as the pedal is held, but all subsequently played notes will not be sustained.

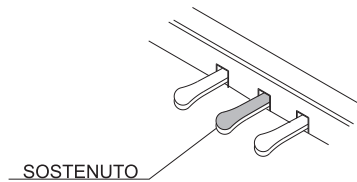

## **Soft Pedal (Left)**

The Soft Pedal controls the sound volume. Press the pedal to decrease the output sound volume.

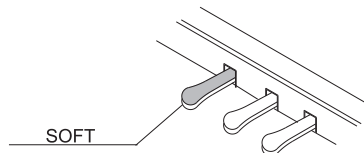

## Adjust the Volume

Use [MASTER VOLUME] control to adjust the volume to your desired level.



## Adjust the Sound

The [TREBLE] fader can be used to adjust the sound of the piano. If the TREBLE fader is pushed to the far left the high frequency of the sound will be decreased, if it is pushed to the right, the high frequency will be increased. Pushing the [BASS] fader to the left will decrease the bass frequency while turning it to the right will increase the bass frequency.

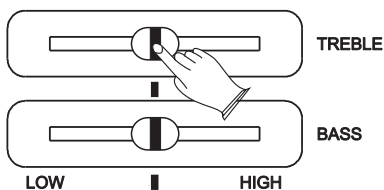

## Demo Play

There are 16 preset piano songs that you can play individually. Here's how you can select and play the demo songs .

### Listen to the Demo Song

Press [DEMO] button to play the demo songs in sequence. Use [DATA ▲/▼] buttons or press the appropriate Voice Select button to select the song you want to play.

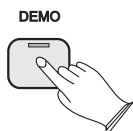

## **Stop Playing**

Press [DEMO] button again to stop playing.

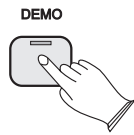

```
01:GrandPno  
Tem:120 Tras:-0-
```

# The Connector Box

The piano features a connection box which allows you to connect external audio equipment, a computer, other MIDI equipment or headphones. The following describes each option in more detail.

## Headphones

Two sets of standard stereo headphones can be plugged in here for private practice or late-night playing. The internal speaker system is automatically shut off when a pair of headphones is plugged into the 1. Headphone jack.

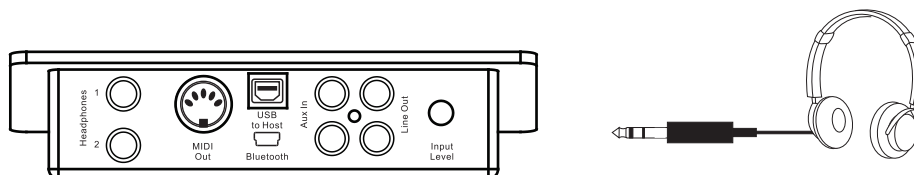

### NOTE

Never use headphones at a high volume, because high volume levels may cause permanent hearing damage.

## MIDI OUT

MIDI (Musical Instrument Digital Interface) is a world-standard communication interface which allows electronic musical instruments to communicate with each other, by sending and receiving compatible note, program change and other types of MIDI data. You should only plug the MIDI out in to another device featuring a MIDI input.

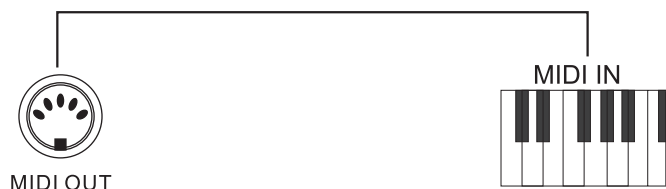



**NOTE**

MIDI OUT Transmits MIDI data to another MIDI device.

**Line OUT**

The piano's stereo RCA line output can be used to deliver the output of the piano to a keyboard amplifier, stereo sound system, mixing console or tape recorder. The piano's internal sound system will remain on unless headphones are plugged in to the 1. Headphone jack.

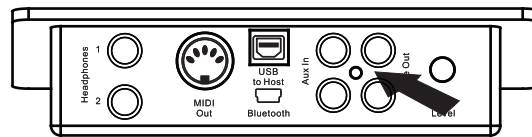

**Using USB-MIDI**

This product allows the transfer of MIDI information over USB to a computer. As complicated this might sound, it's actually pretty straight forward. Because your piano is USB Class Compliant, there is no need to install a driver to enable it to work with compute. Simply just plug it in and the OS will do the rest. The piano will work with all standard MIDI based computer software.

USB AUDIO interface is a digital audio interface. By USB cable, you can digitally transfer intact audio signals of PC to this instrument, and enjoy it on this instrument or use it for accompany when you play this instrument; likewise, you can transfer intact audio signals of the instrument to PC to record and edit music.

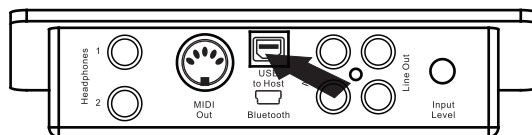

**NOTE**

The piano also support the USB Audio.

## Aux In

The Aux In stereo RCA connectors allow you to mix an external sound source (such as a CD player, MP3 player or computer output) with the piano's internal sounds, for playback through the piano's built-in speakers or headphone outputs.

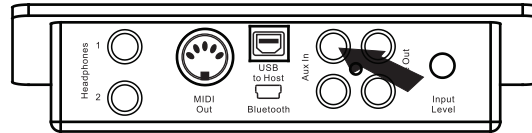

The Aux In signal level can be adjusted using the Input Level knob.

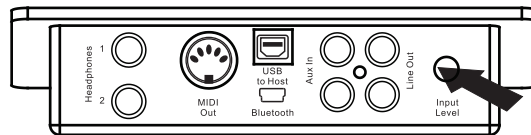

## Blue tooth

This piano can support Blue tooth with the Connection of the Blue tooth jack, Reference: Blue tooth.

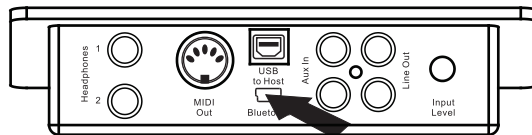

# Voices

Your instrument has 128(01-128) GM standard voices.  
72(129-200) XM voices(include 8 percussion kits and 1 set of sound effect) that you can select and play.

## Selecting a Voice

To select a voice, press the appropriate Voice Select button on the right side of the front panel.

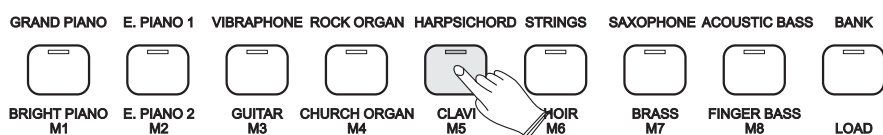

### NOTE

When [BANK/LOAD] button is unlighted, you can press the appropriate button to select the voice above the button.  
When [BANK/LOAD] button is lighted, you can press the appropriate button to select the voice below the button.

## Setting a Voice

You can set other voices by Pressing [USER/STORE] button and the user indicator is lighted.

In USER voice Mode, Hold down the appropriate voice select button or 3 seconds, the [USER/STORE] and DIRECT VOICE led is flashing, use [DATA ▲/▼] or [GROUP ▲/▼] buttons to set the voice you want to set into the direct user voice button.

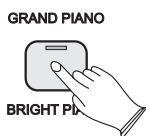

### **NOTE**

When [BANK/LOAD] button is unlighted, you can press the appropriate button to select the voice above the button.  
When [BANK/LOAD] button is lighted, you can press the appropriate button to select the voice below the button.

## **Group Function**

In this function, you can select voice, volume, touch in a fast select mode.

Press [Group ▲/▼ ] buttons you can set the value not just by one.

Press [Group ▲/▼ ] buttons at the same time, you can set the settings to default value.

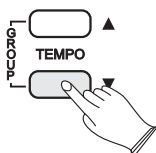

## **Dual Mode**

Press [DUAL] button to select layer voice mode, two voices will sound simultaneously when you play keyboards.

### **Select Dual Voice**

Press [DUAL] button , the Dual indicator is flashing, then press the voice select button to select the second voice.

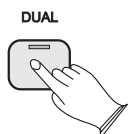

```
49:Ensmble1
Tem:120 Tras:-0-
```

## **Setting the Dual Voice Volume**

Reference: Adjusting Keyboard Volume(P.15).

## **Exit the Dual Mode**

Press [DUAL] button again, the Dual indicator turns off and the Dual mode is no longer active.

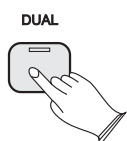

```
01:GrandPho
Tem:120 Tras:-0-
```

## **Split Mode**

Press [SPLIT] button to select split mode, your keyboard will be split into two sections which means different voices can be played with the left and right hands at the same time.

## **Select Split Voice**

Press [SPLIT] button, the Split indicator is flashing, then press the voice select button to select the second voice.



```
33:AcstBass
Tem:120 Tras:-0-
```

## **Changing the Split Point**

Hold down the [SPLIT] button for about 2 second, then play any of the keys on the keyboard to select the split point.

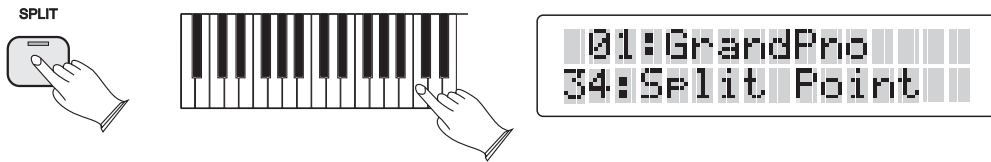

## **Setting the Split Voice Volume**

**Reference:** Adjusting Keyboard Volume(P.14).

## **Exit the Split Mode**

Press [SPLIT] again, the Split indicator turns off and the Split mode is no longer active.

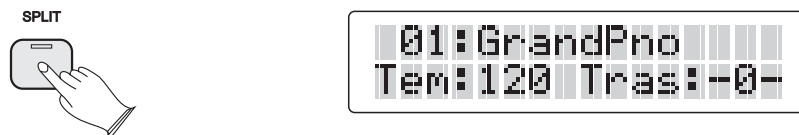

## **Adjusting Keyboard Volume**

Use this function can adjust the Split Voice Volume, Dual Voice Volume and the Main Voice Volume.

### **Split Voice Volume**

In Split mode, when the Split indicator is flashing, press [KBD.VOL] button can adjust the split voice volume, while the split indicator is lit, you can user [DATA ▲/▼] or [GROUP ▲/▼] buttons to select volume.



```
33:AcstBass
100:Split.Vol
```

## **Dual Voice Volume**

In Dual mode, when the Dual indicator is flashing, press [KBD.VOL] button can adjust the Dual voice volume, while the dual indicator is lit., you can use [DATA ▲/▼] or [GROUP ▲/▼] buttons to select volume.



```
49:Ensmble1
50: Dual.Vol
```

## **Main Voice Volume**

You can adjust the main voice volume by pressing [KBD.VOL] button when the dual or split Cursor does not flash, you can use [DATA ▲/▼] or [GROUP ▲/▼] buttons to select volume.



```
01:GrandPno
100:Main.Vol
```

## Effect

This function allows you to perform the overall sound in a realistic style.

### Reverb

The [REVERB] button selects a number of digital reverb effects that you can use for extra depth and expressive power.

Press [REVERB] button can turn off or turn on the reverb effect. Press [REVERB] button, use [DATA ▲/▼] or [GROUP ▲/▼] buttons to select reverb type. No reverb is produced when you press [REVERB] button again and the LCD will display 'RevType:Off' . Default type: Hall1

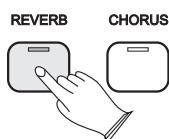

01:GrandPno  
RevType:Hall1

The reverb types in the list below can be selected from the reverb display.

1	2	3	4	5	6	7	8
Hall1	Hall2	Room1	Room2	Room3	Stage1	Stage2	Plate

#### **NOTE**

Press [REVERB] button repeatedly to turn on or turn off the reverb effect.

### **Adjusting Reverb Depth**

**Reference:** "Main Reverb Level", "Split Reverb Level", "Dual Reverb Level" (P.28).



## Chorus

Shimmering, broadening effect. Press [CHORUS] button, use [DATA ▲/▼] or [GROUP ▲/▼] buttons to select chorus type. No chorus is produced when you select 'CheType:OFF', and the indicator is off.

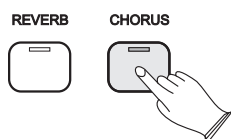

The chorus types in the list below can be selected from the chorus display.

1	2	3	4	5	6	7	8
Chorus1	Chorus2	Chorus3	Chorus4	Feedback	Flanger1	ShrtDely	ShrtDIFb

### NOTE

Press [CHORUS] button repeatedly to turn on or turn off the chorus effect.

## Adjusting Chorus Depth

**Reference:** "Main Chorus Level", "Split Chorus Level", "Dual Chorus Level" (P.29).

## Touch

The touch function provides four different types of keyboard touch sensitivity that can be selected to match different playing styles.

Press the [TOUCH] button, use [DATA ▲/▼ ] or [GROUP ▲/▼ ] buttons to select the touch sensitivity type .

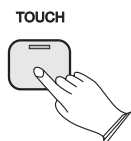

No.	Name	Description
01	Normal	is defined as a curve which will be mid-way between the other two.
02	Hard	is defined as a curve which makes it easier to play quietly. The curve generates lower velocities for the same force
03	Soft	is defined as a curve which makes it easier to play loudly. The curve generates higher velocities for the same force.

## **Setting Fixed Touch Value**

Press [TOUCH] button repeatedly to select: TouchFixed , LCD will display: TouchFixed:90. It means that regardless of how hard you play, the keyboard will transmit a velocity value of 90. Then use [DATA ▲/▼ ] or [GROUP ▲/▼ ] buttons to select the touch sensitivity default value.



When touch is selecting, press [DATA ▲/▼ ] or [GROUP ▲/▼ ] buttons simultaneously to reset the touch to default value (90).

## **Transpose**

The Transpose function allows you to change the pitch of the instrument in semitone steps, up to a maximum setting of 12 semitones (a maximum of one octave up or down).

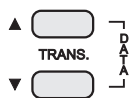

Use [TRANSPOSE ▲/▼ ] buttons to transpose up or down as required. The transposition range is from “-12” (down one octave) through “0” (normal pitch) to “12” (up one octave).

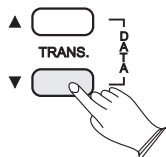

## Tempo

This function allows you to set the tempo by [TEMPO ▲/▼] button. Press [TEMPO ▲/▼] button, you can adjust the speed from 20 to 280. Press these two buttons at the same time, the speed return to 120.

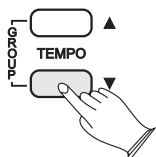

## Metronome

Metronome is a convenient feature for practice, and it can also provide a solid rhythmic guide when recording.

The metronome sound is alternately turned on and turned off by pressing [METRONOME] button.

The time signature of the metronome can be set by using [DATA ▲/▼ ] or [GROUP ▲/▼ ] buttons while turning on the metronome function.

Time signature: 1/4, 2/4, 3/4, 4/4, 5/4, 6/4, 3/8, 6/8, 7/8, 9/8, 12/8.



## Twin Mode

Press [TWIN] button to select Twin mode. In this mode, the keyboard will be separated into two play areas.

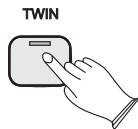

Press [TWIN] button again to exit the Twin mode.

# Function

Press [FUNCTION] button to enter the menu of function. The default option of the menu is Performance. Press [FUNCTION] button repeatedly to select the option to be set, then press [GROUP ▲/▼] button to select each option, press [DATA ▲/▼] button to set the parameter. The option and the parameters are as the follows:

Function type		LCD display	Range	Default
Performance?	Master Tune	Master Tune?	-64~63	00
	Main Octave	Main Octave?	-02~02	00
	Split Octave	Split Octave?	-02~02	00
	Dual Octave	Dual Octave?	-02~02	00
	Split Point	Split Point?	00~87	34
	Metro. Type	Metro. Type?	1/4, 2/4, 3/4, 4/4, 5/4,6/4, 3/8, 6/8, 7/8, 9/8,12/8	4/4
Mixer?	Metro Volume	Metro Volume?	00~127	100
	Song Volume	Song Volume?	00~127	127
	Main Pan	Main Pan?	-64~63	00
	Split Pan	Split Pan?	-64~63	00
	Dual Pan	Dual Pan?	-64~63	00

Funtion type		LCD display	Range	Default
Effect?	Main RevVol	Main RevVol?	0~127	32
	Split RevVol	Split RevVol?	0~127	32
	Dual RevVol	Dual RevVol?	0~127	32
	Main ChrVol	Main ChrVol?	0~127	110
	Split ChrVol	Split ChrVol?	0~127	110
	Dual ChrVol	Dual ChrVol?	0~127	110
Midi Setting?	All Local	All Local?	On/Off	On
	USB MIDI In	USB MIDI In?	On/Off	On
	MIDI Out	MIDI Out?	01~16, Off (Not Include 10)	01
Usb Setting?	USB Play Mode	USB Play Mode?	01Single, 02Play All Songs, 03Random	01Single
	USB Play Speed	USB Play Speed?	50%~200%	100%
	USB Play Volume	USB Play Vol?	0~127	127
	USB Mute Track	USB Mute Track?	01~16	01
	Auto RecTrack	Auto RecTrack?	On/Off	On
	Main RecTrack	Main RecTrack?	01~16, Off	01
	Split RecTrack	Split RecTrack?	01~16, Off	02
	Dual RecTrack	Dual RecTrack?	01~16, Off	03

Function type		LCD display	Range	Default
Other Setting?	Song Grading	Song Grading?	On/Off	On
	Bluetooth	Bluetooth?	On/Off	Off
	Reset	Reset?	Resetmem!	—
	Auto Power Off	Auto Power Off?	20~60 min, Off	30 min

## Master Tune

This function makes it possible to tune the pitch of your instrument to match other instruments. The tune range is from -64 (down one semitone) through 0 (normal pitch) to 63 (up one semitone).

Press [FUNCTION] button repeatedly to select "Performance?".  
 Press [GROUP▲/▼] button repeatedly to select "Master Tune?".  
 Press [DATA▲/▼] button to set the master tune value.

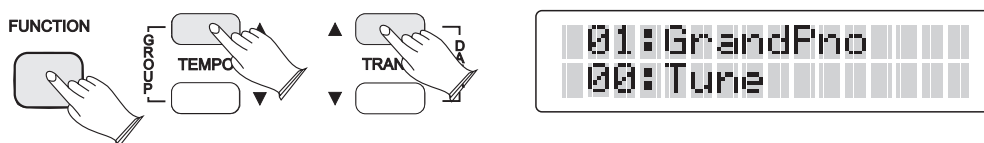

## Main Octave

This function allows you to set the main voice octave.

Press [FUNCTION] button repeatedly to select "Performance?".  
 Press [GROUP▲/▼] button repeatedly to select "Main Octave?".  
 Press [DATA▲/▼] button to set the main octave value.

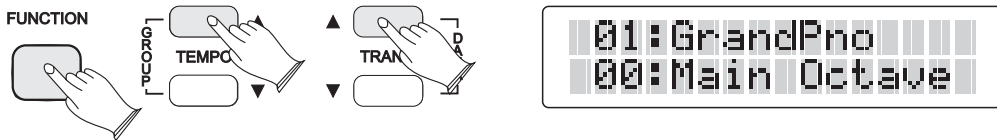

## Split Octave

This function allows you to set the split voice octave.

Press [FUNCTION] button repeatedly to select "Performance?".  
 Press [GROUP▲/▼] button repeatedly to select "Split Octave?",  
 Press [DATA▲/▼] button to set the split octave value.

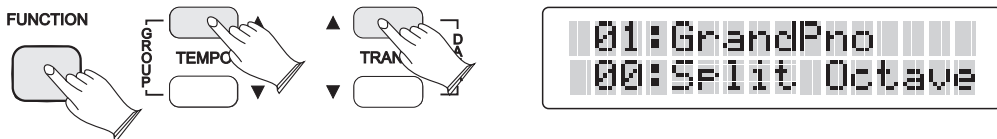

## Dual Octave

This function allows you to set the dual voice octave.

Press [FUNCTION] button repeatedly to select "Performance?".  
 Press [GROUP▲/▼] button repeatedly to select "Dual Octave?",  
 Press [DATA▲/▼] button to set the dual octave value.

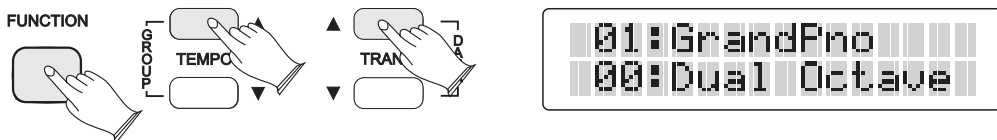



## Split Point

This function allows you to set the split point value.

Press [FUNCTION] button repeatedly to select "Performance?".

Press [GROUP▲/▼] button repeatedly to select "Split point?",

Press [DATA▲/▼] button to set the split point value.

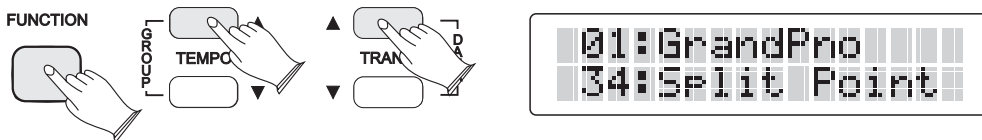

## Metro Type

Metronome is a convenient feature for practice, and it can also provide a solid rhythmic guide when recording.

Press [FUNCTION] button repeatedly to select "Performance?".

Press [GROUP▲/▼] button repeatedly to select "Metro Type?",

Press [DATA▲/▼] button to select the metronome type.

Time signature: 1/4, 2/4, 3/4, 4/4, 5/4, 6/4, 3/8, 6/8, 7/8, 9/8, 12/8. (Default: 4/4)

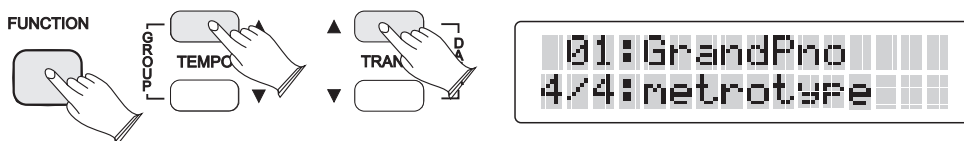

## Metro Volume

This function allows you to set the metronome volume value.

Press [FUNCTION] button repeatedly to select "Mixer?".

Press [GROUP▲/▼] button repeatedly to select "Metro Volume?",

Press [DATA▲/▼] button to set the metronome volume value.

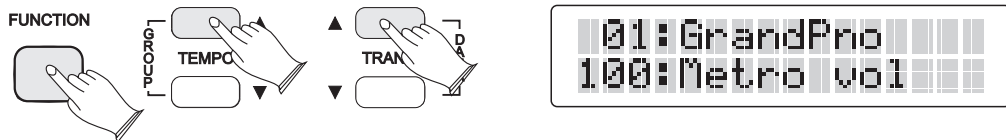

## Song Volume

This function allows you to set the song volume value.

Press [FUNCTION] button repeatedly to select "Mixer?".

Press [GROUP▲/▼] button repeatedly to select "Song Volume?",

Press [DATA▲/▼] button to set the song volume value.

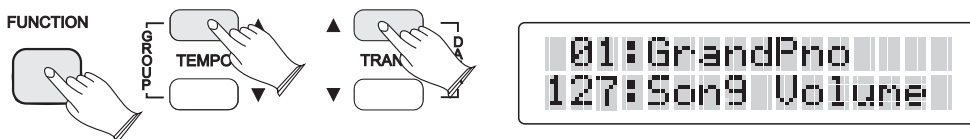

## Main Pan

In this function you can set the stereo position of each orchestration part to create a board stereo image of your sound.

Press [FUNCTION] button repeatedly to select "Mixer?".

Press [GROUP▲/▼] button repeatedly to select "Main Pan?",

Press [DATA▲/▼] button to set the main pan value.

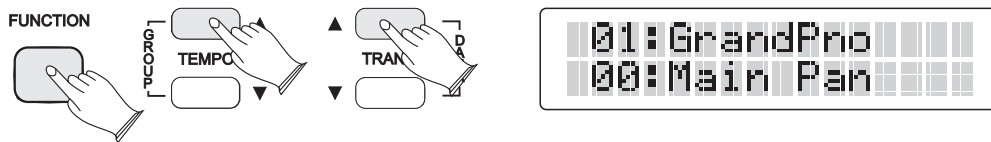

## Split Pan

Press [FUNCTION] button repeatedly to select "Mixer?".  
 Press [GROUP▲/▼] button repeatedly to select "Split Pan?",  
 Press [DATA▲/▼] button to set the split pan value.

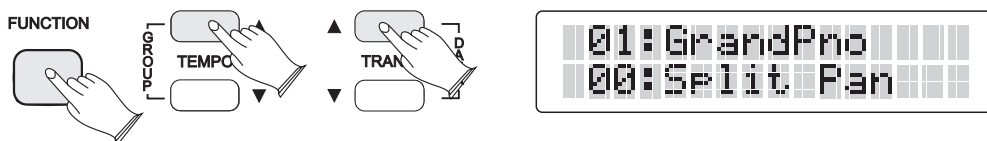

## Dual Pan

Press [FUNCTION] button repeatedly to select "Mixer?".  
 Press [GROUP▲/▼] button repeatedly to select "Dual Pan?",  
 Press [DATA▲/▼] button to set the dual pan value.

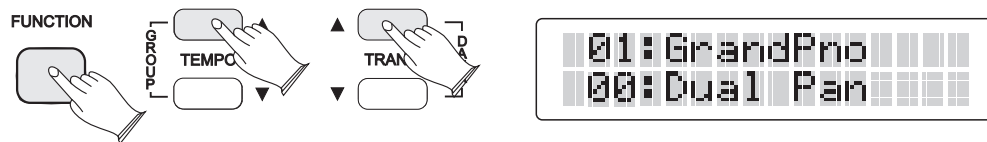

## Main Reverb Level

In this function you can adjust the main reverb level for the selected voice.

Press [FUNCTION] button repeatedly to select "Effect?".

Press [GROUP▲/▼] button repeatedly to select "Main RevVol?",

Press [DATA▲/▼] button to set the main reverb level value.

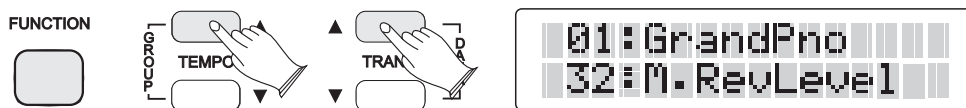

## Split Reverb Level

In this function you can adjust the split reverb level for the selected voice.

Press [FUNCTION] button repeatedly to select "Effect?".

Press [GROUP▲/▼] button repeatedly to select "Split RevVol?",

Press [DATA▲/▼] button to set the split reverb level value.

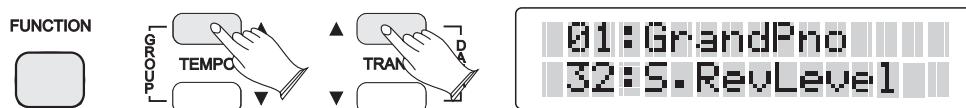

## Dual Reverb Level

In this function you can adjust the dual reverb level for the selected voice.

Press [FUNCTION] button repeatedly to select "Effect?".

Press [GROUP▲/▼] button repeatedly to select "Dual RevVol?",

Press [DATA▲/▼] button to set the dual reverb level value.

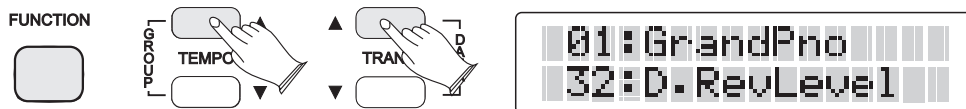

## Main Chorus Level

In this function you can adjust the main chorus level for the selected voice.

Press [FUNCTION] button repeatedly to select "Effect?".  
 Press [GROUP▲/▼] button repeatedly to select "Main ChrVol?",  
 Press [DATA▲/▼] button to set the main chorus level value.



## Split Chorus Level

In this function you can adjust the split chorus level for the selected voice.

Press [FUNCTION] button repeatedly to select "Effect?".  
 Press [GROUP▲/▼] button repeatedly to select "Split ChrVol?",  
 Press [DATA▲/▼] button to set the split chorus level value.

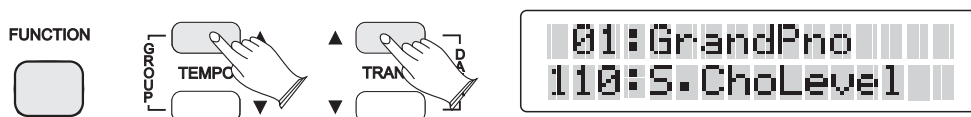

## Dual Chorus Level

In this function you can adjust the Dual chorus level for the selected voice.

Press [FUNCTION] button repeatedly to select "Effect?".

Press [GROUP▲/▼] button repeatedly to select "Dual ChrVol?",

Press [DATA▲/▼] button to set the dual chorus level value.

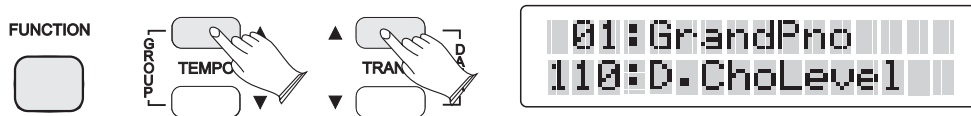

## All Local

In this function you can turn on or turn off the speaker system of your keyboard.

Press [FUNCTION] button repeatedly to select "Midi Setting?".

Press [GROUP▲/▼] button repeatedly to select "All Local?",

Press [DATA▲/▼] button to select On or Off.

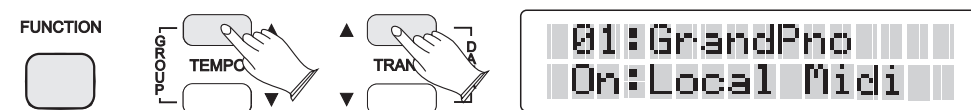

On----- Normal operation. Keyboard and controllers are sent to the sound engine

Off----- There will be no sound produced by the brain's tone generator. MIDI function can work as usual.

## USB MIDI In

This function allow you to turn on or off the MIDI function.  
The default is On.

Press [FUNCTION] button repeatedly to select "Midi Setting?".  
Press [GROUP▲/▼] button repeatedly to select "USB Midi In?",  
Press [DATA▲/▼] button to turn on or turn off the Midi function.

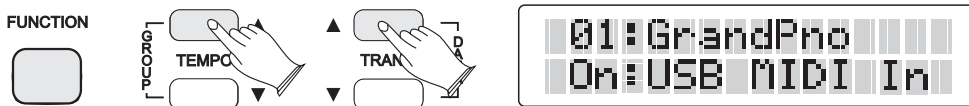

## MIDI Out

This function allow you to select the MIDI transmission track from 01-16 or to turn the MIDI transmission function off, the default track is channel 1.

Press [FUNCTION] button repeatedly to select "Midi Setting?".  
Press [GROUP▲/▼] button repeatedly to select "MIDI Out?",  
Press [DATA▲/▼] button to select midi out track 01~16 (Not include 10) or turn Off this track.

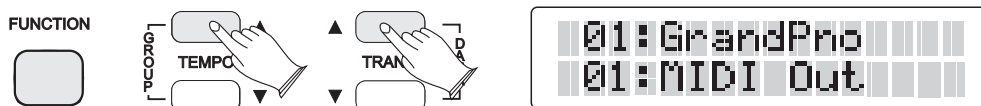

## USB Play Mode

Midi file playing mode in the USB Flash Drive can be set here. Three playing method can be selected.

In this page, you can select the setting for the song. It is possible in fact to play the songs listed in the USB disk.

Press [FUNCTION] button repeatedly to select "Usb Setting?".  
Press [GROUP▲/▼] button repeatedly to select "USB Play Mode?",  
Press [DATA▲/▼] button to select USB play mode: 1Single, 2Play All Songs, 3Random.

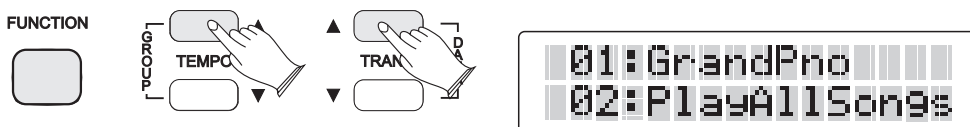

01Single----- Single play  
02Play All Songs-----Order play  
03Random-----Random play

## USB Play Speed

This function allows you to select the play back speed for USB on the piano.

Press [FUNCTION] button repeatedly to select "Usb Setting?".  
Press [GROUP▲/▼] button repeatedly to select "USB Play Speed?",  
Press [DATA▲/▼] button to select USB play speed value.

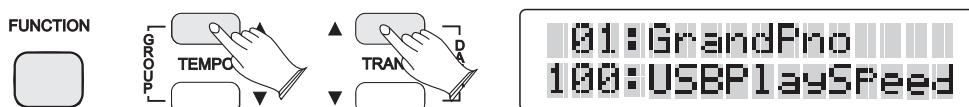



## USB Play Volume

This function allows you to adjust the USB play back volume of the piano.

Press [FUNCTION] button repeatedly to select "Usb Setting?".  
Press [GROUP▲/▼] button repeatedly to select "USB PlayVol?",  
Press [DATA▲/▼] button to set USB play volume value.

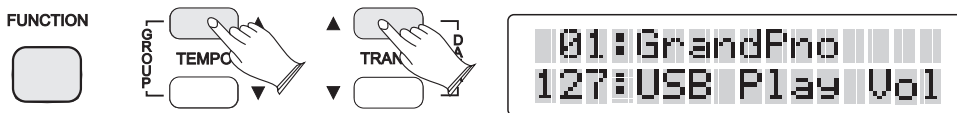

## USB Mute Track

This function allows you to mute a track on the USB play back of the piano. You can mute any track from 01-16 by selecting it in this function menu.

Press [FUNCTION] button repeatedly to select "Usb Setting?".  
Press [GROUP▲/▼] button repeatedly to select "USB Mute Track?",  
Press [DATA▲/▼] button to select "Mute Track01?"  
Press [GROUP▲/▼] button to select "Mute Track01?" ~ "Mute Track16?".  
Press [DATA▲/▼] button to set Yes or No for the track to mute.

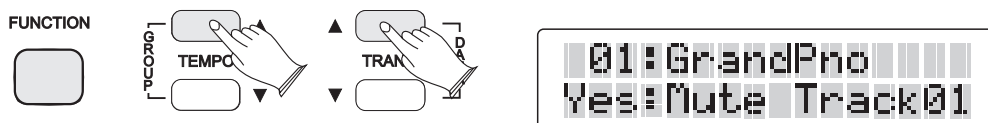

## Auto RecTrack

Here you can turn on or turn off Auto Track function for recording mode.

Press [FUNCTION] button repeatedly to select "Usb Setting?".  
Press [GROUP ▲/▼] button repeatedly to select "Auto RecTrack?",  
Press [DATA ▲/▼] button to select On or Off.

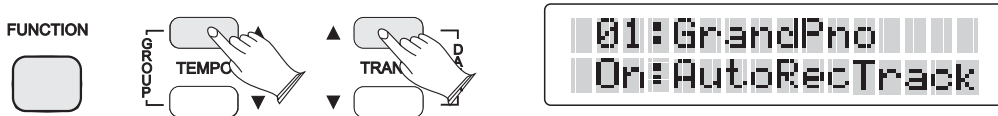

On Auto RecTrack----- when you want to record more tracks data, select On Auto RecTrack , the instrument brain will assign the next track for you automatically.

Off Auto RecTrack----- When you want to select tracks by yourself, here you have to select Off Auto RecTrack function first, then select tracks by yourself.

## Main RecTrack

This function allows you to select main voice track on the USB record of the piano. If you select tracks by yourself, you must turn Auto Rectrack Off.

Press [FUNCTION] button repeatedly to select "Usb Setting?".  
Press [GROUP ▲/▼] button repeatedly to select "Main RecTrack?",  
Press [DATA ▲/▼] button to select main record tracks: 01~16 and Off.

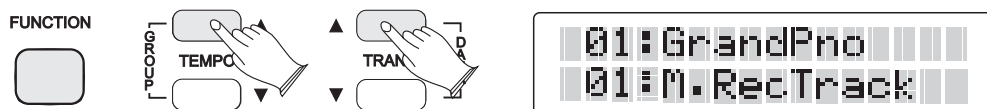

## Split RecTrack

This function allows you to select split voice track on the USB record of the piano. If you select tracks by yourself, you must turn Auto Rectrack Off.

Press [FUNCTION] button repeatedly to select "Usb Setting?".  
Press [GROUP▲/▼] button repeatedly to select "Split RecTrack?",  
Press [DATA▲/▼] button to select split record tracks: 01~16 and Off.

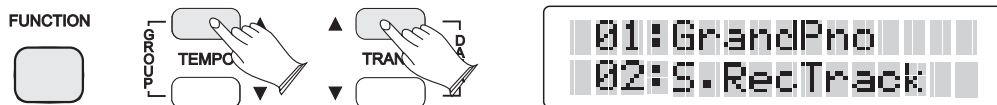

## Dual RecTrack

This function allows you to select dual voice track on the USB record of the piano. If you select tracks by yourself, you must turn Auto Rectrack Off.

Press [FUNCTION] button repeatedly to select "Usb Setting?".  
Press [GROUP▲/▼] button repeatedly to select "Dual RecTrack?",  
Press [DATA▲/▼] button to select split record tracks: 01~16 and Off..



## Song Grading

This function is in the song learning mode, when playing songs, it will automatically score based on your performance: 01~100.

Press [FUNCTION] button repeatedly to select "Other Setting?".  
Press [GROUP▲/▼] button repeatedly to select "Song Grading?",  
Press [DATA▲/▼] button to select On or Off.

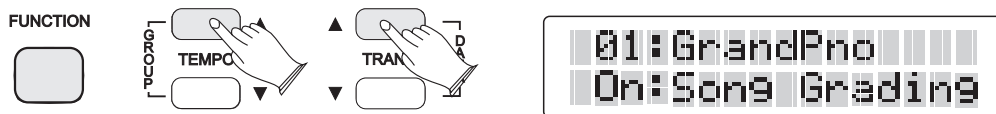

On----- Turn on the song grading function.

Off----- Turn off the song grading function.

## Bluetooth

Plug the tiny Bluetooth receiver into the allotted slot on the connector panel to stream audio from Bluetooth devices onto your piano.

This function allows you to turn Bluetooth on or off while the receiver is engaged, the default setting is Bluetooth off.

Press [FUNCTION] button repeatedly to select "Other Setting?".  
Press [GROUP▲/▼] button repeatedly to select "Bluetooth?",  
Press [DATA▲/▼] button to select On or Off.

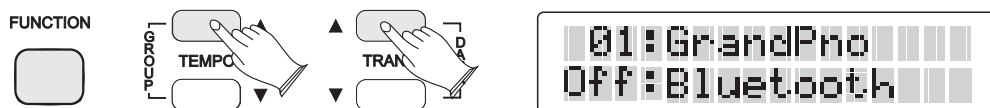

On----- Turn on the Bluetooth function.

Off----- Turn off the Bluetooth function.

## Reset

You can Reset your piano to the initial factory settings. Please be aware that this will erase all saved data from the User buttons, the Registration memory banks and the song banks and all the changed settings from the Function menu.

Press [FUNCTION] button repeatedly to select "Other Setting?". Press [GROUP▲/▼] button repeatedly to select "Reset?", Press [DATA▲/▼] button to confirm.

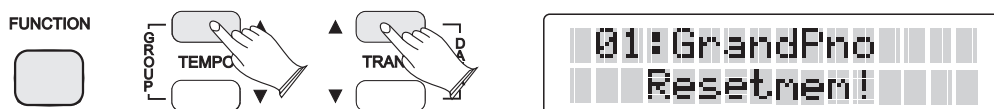

## Auto Power Off

This piano will automatically power off after a preset time of inactivity. Set the length of standby time before a power down in this function menu.

Press [FUNCTION] button repeatedly to select "Other Setting?". Press [GROUP▲/▼] button repeatedly to select "Auto Power Off?", Press [DATA▲/▼] button to select auto power off time: 20min~60min or Off.

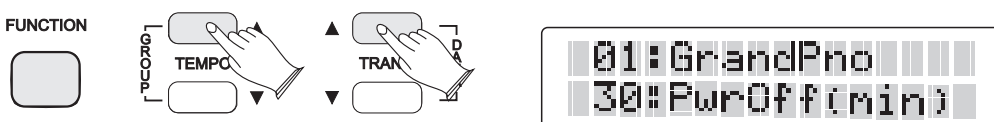

# Registration Memory

Your instrument registration memory can be used to store eight sets of voice settings that can be recalled during you playing.

## Store

Hold the [USER] button, then press the voice select button to store the settings SAVE M1~SAVE M8.

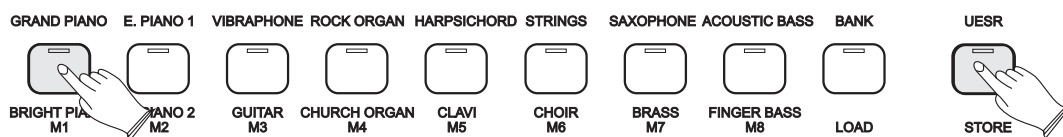

## Load

Hold the [BANK/LOAD] button, then press the voice select button to load the settings Load M1~Load M8.

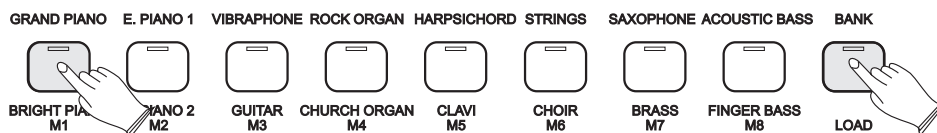

## NOTE

Anytime you store to a REGISTRATION MEMORY button, all settings previously stored in that button will be erased and replaced by the new settings.

## Saving Registration Data to USB Disk

Insert the USB Disk into the USB terminal.

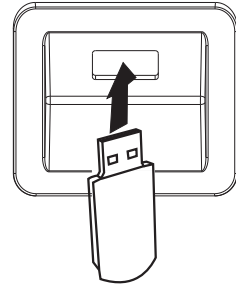

Press [USB MEMORY] button, then press [GROUP▲/▼] or [DATA▲/▼] to select "Save REG To USB?", then press [PLAY] button, display shows Save OK!

A message "xx: REG\_\_xxx" ("xx" indicates this file's sequence Number In Udisk. "REG\_\_xxx" indicates registration file number ) appears, indicating your Registration Memory Settings are saved to USB Disk, with 8 Registrations stored to a single file.

USB MEMORY



01:REG__001									

## Read Registration Data From USB Disk

Insert the USB Disk into the USB terminal. Use [GROUP▲/▼] or [DATA▲/▼] to select REG file, then press [PLAY] button, display shows "Load OK!". (Or Press [USB MEMORY] button, then press [GROUP▲/▼] or [DATA▲/▼] to select "Load REG File?", then press [PLAY] button, display shows Load OK!)

USB MEMORY



8 Registrations will be loaded to the memory store on the panel. You can recall the information you have loaded by pressing [BANK/LOAD] button and [M1]-[M8] buttons.

### Delete REG File from USB

Insert the USB Disk into the USB terminal. Press [GROUP▲/▼] or [DATA▲/▼] buttons to select REG file you want to delete, then hold down the [RECORD] button and press [PLAY] button.

LCD shows:



Press [DATA ▲] button to delete the file.

Press [DATA ▼] button to cancel the file.



# Recording

This digital piano lets you record your performances and Registration settings to a USB Disk. Each user song lets you record up to sixteen independent tracks. These include the voices for the keyboard performance.

It provides two different ways to record: USB Recording and Melody Track Recording. Melody Track Recording, which can save into local memory. Two Tracks recording can be save into USB disk as a MIDI File and the MIDI file in the USB disk can be load to local memory.

## Quick Recording

### 1.1. Insert the USB Disk into the USB Terminal

### 1.2. Start Recording

Press the [RECORD] button and the button indicator is flashing, then you can start recording. (The first one measures are tempo prompt only. It cannot record any data).



### 1.3. Stop Recording

Press [RECORD] button again to stop recording. Recording stops and your performance is written to the song. The song to which your performance is recorded is automatically named xx:SONGxx (xx indicates this file's sequence Number in Udisk. SONGxx indicates the recording file number). You can edit the song as desired by computer or midi edit soft.

Quick Recording automatically makes track assignments as below:

Track 1----- Main Voice  
Track 2----- Split Voice  
Track 3----- Dual Voice

## Multi Track Recording

Multi track recording provides two ways to record:

1. Use Auto Track Assignment.
2. Select Tracks by yourself.

### 1. Use Auto Track Assignment

1.1 Insert the USB disk into the USB terminal

1.2 Turn the Auto Track On

**Reference:** Function Auto RecTrack(P.34).

1.3 Press the [RECORD] button to start recording.

(The first one measures are tempo prompt only. It cannot record any data).

1.4 Press [RECORD] button again to stop recording.

Recording stops and your performance is written to the song. The song to which your performance is recorded is automatically named xx:SONG xx (xx indicates the song file number. SONGxx is the song's name).

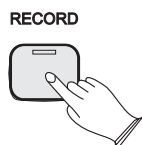

1.5 Hold down [USB MEMORY] button , then press [RECORD] button to Recording.

(When the recording is finished, the recording file will be saved as a new file named XX:SONGXX-1.)

1.6 Use the same operation as step 5 to record more tracks. The name of the new file will be saved in sequence.

## 2.Select Tracks by yourself.

2.1 Insert the USB disk Into the USB terminal.

2.2 Turn the Auto Track Off

**Reference:** Function Auto Track(P.34).

2.3 Press the [RECORD] button to start recording.

(The first one measures are tempo prompt only. It cannot record any data).

2.4 Press [RECORD] button again to stop recording.

Recording stops and your performance is written to the song. The song to which your performance is recorded is automatically named "xxSONG xx" ("xx" indicates the song file number. "SONGxx" is the song's name).

2.5 Select Recording Track

**Reference:** "Main RecTrack", "Split RecTrack", "Dual RecTrack" (P.34~P.35).

If you record Main Voice only, please turn off the Split Track and Dual Track.

2.6 Hold down the [USB MEMORY] button, then press [RECORD] button, when the recording is finished, the recording file will be saved as a new file named "01:SONG01-1".

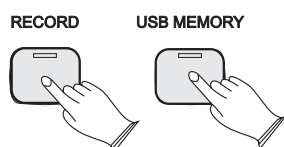

```
01:SONG01-1  
Tem:120 Tras:-0-
```

2.7 Use the same operation as Step 5 and Step 6 to record more tracks. The name of the new file will be saved in sequence.

## Melody Track Recording

### 3.1 Melody Track1 Recording

Hold down the [RECORD] button, and then press the [TRACK1/LEFT] button, the [TRACK1/LEFT] and the [RECORD] indicator flashes to indicate ready to record. You can start recording simply by playing the key board. (The first one measures are tempo prompt only. It cannot record any data).

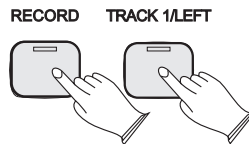

Press the [RECORD] button again to stop recording and the data will save to local memory track1.

#### **NOTE**

If the TRACK 2 has data recorded, the indicator will light and it will play when the record is started. You can press the [TRACK 2/RIGHT] button to mute it, then the indicator will be unlighted.

### 3.2 Melody Track2 Recording

Hold down the [RECORD] button, and then press the [TRACK2/RIGHT] button, the [TRACK2/RIGHT] and the [RECORD] indicator flashes to indicate ready to record. You can start recording simply by playing the key board. (The first one measures are tempo prompt only. It cannot record any data).

Press the [RECORD] button again to stop recording and the data will save to local memory track 2.

#### **NOTE**

If the TRACK 1 has data recorded, the indicator will light and it will play when the record is started. You can press the [TRACK 1/LEFT] button to mute it, then the indicator will be unlighted.

### **3.3 Play the Local Track Recording**

Press the [PLAY] to play the local recording. During song playback you can select which track you wish to hear by press the [TRACK 1/LEFT] or [TRACK2/RIGHT] button.

### **3.4 Delete the Local Track Recording**

If the TRACK 1 has data recorded, hold the [TRACK 1/LEFT] button for 3 seconds and the LCD will display: "Delete Track1?". Press [DATA▲] to delete. Press [DATA▼] to cancel.

If the TRACK 2 has data recorded, hold the [TRACK 2/RIGHT] button for 3 seconds and the LCD will display: "Delete Track2?". Press [DATA▲] to delete. Press [DATA▼] to cancel.

## **Saving the Recording to USB Disk**

Insert the USB Disk into the USB terminal.

Press the [USB MEMORY] button, Press [GROUP▲/▼] or [DATA▲/▼] buttons to select: Save TCK To USB, then press [PLAY] button, display shows Save OK!

A message "xx:Song xx" (xx indicates this file's sequence Number in Udisk. Songxx indicates registration file number ) appears, indicating your record are saved to USB Disk.

USB MEMORY



## **Load MIDI File**

Insert the USB Disk into the USB terminal.

Press the [USB MEMORY] button, Press [GROUP▲/▼] or [DATA▲/▼] to select "Load MIDI File?", Then press [PLAY] button, display shows "Load OK!".

USB MEMORY



## Delete Song

Insert the USB Disk into the USB terminal. Press [GROUP▲/▼] or [DATA▲/▼] buttons to select SONGxx file you want to delete, hold down the [PLAY] button and press the [RECORD] button .



Press [DATA ▲] button to delete the file.  
Press [DATA ▼] button to cancel the file.

## USB Memory Button

Use this button you can switch to USB mode immediately even the keyboard is in any of other mode.

Insert the USB DISK into the USB socket, press [USB MEMORY] button, if your disk is locked or no supported file in it, the display will show: No Files.

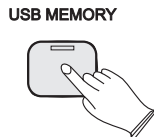

press [USB MEMORY] button, then press [GROUP▲/▼] or [DATA▲/▼] buttons to select "Save Tck To USB?", "Save REG To USB?", "Load Midi File?", "Load REG File?".

## **Mute Track**

Use this function you can turn on or turn off any tracks before song playing or recording.

**Reference:** Function "USB Mute Track"(P33).

## **Adjust the Song's volume**

Use the [Function] button to adjust the Song's volume to your desired level.

**Reference:** Function "USB Play Volume"(P.33).

## Teaching Function

There are 55 learning songs built into this Piano for your musical enjoyment. These songs have separate left and right-hand parts that can be turned on and off as required so you can practice the corresponding part on the piano.

### Selecting a Song

Turn on the song mode by press [LEARN] button. The song number will appear on the LCD display, [LEARN] and [PLAY] button indicators in flashing.

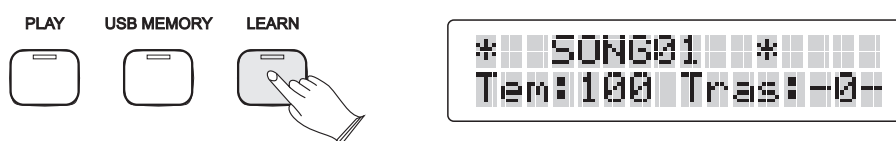

Use [DATA▲/▼] buttons to select a song. Press [LEARN] button to start learn the song and its indicator in light.

### Listening to the Entire Song

- 1). With the play along song mode engaged, press the [PLAY] button to hear both hand parts playing the entire song.
- 2). Press the [PLAY] button again to stop.

### Practicing the Right Hand of the Selected Song

- 1). With the play along song mode engaged, press the [TRACK2/RIGHT] button to mute the right hand part. The right indicator lights up.



- 2). Press the [LEARN] button. Its indicator lights up and you will hear the metronome "count in" beginning of the song. You will then hear the left-hand part.
- 3). Play the right-hand part of your selected song while the left-hand part plays.
- 4). Press the [LEARN] button again to stop. Otherwise, playback will stop automatically at the end of the song.

### **Practicing the Left Hand of the Selected Song**

Follow steps 1-4 listed above, substituting the LEFT button whenever RIGHT button is mentioned. You will hear the right-hand part of your selected song. Play the left-hand part of your selected song while the right-hand part plays.

### **Practicing the Both Hands of the Selected Song**

- 1). Holding down the [LEARN] button, the play along song mode is engaged .
- 2). Press the [TRACK1/LEFT] button first, then the [TRACK2/RIGHT] button.
- 3). Press the [LEARN] button. Its indicator lights up and you will hear the metronome "count in" the song.
- 4). Play the left-hand and right-hand parts of your selected song.
- 5). Press the [LEARN] button again to stop.
- 6). Hold the [LEARN] button to exit.

#### **NOTE**

When you finishes your performance, the function will automatically score your performance ranging 01 to 100. Reference: "Grading" in function menu. (P.36)

# Bluetooth

## Bluetooth Connection

Plug this tiny unit into the allotted slot on the connector panel and stream high-quality audio from Bluetooth devices like your smartphone, tablet or computer. Now you will be able to listen to music files and music apps from your Bluetooth - enabled devices on your piano.



### SPECIFICATIONS

Compliant with Bluetooth 2.1+EDR specs    4dBm output max power  
Operates in 2.402-2.480 GHz ISM band    80dBm receiver sensitivity

The included Bluetooth receiver turns your piano into a home entertainment center for the entire family and allows you to play along with your favorite hits.

1). Make sure that the piano is powered off, if not please press the [STANDBY/ON] button to do so. Insert the Bluetooth receiver into the Bluetooth slot located on the connector panel on the left side of the piano underneath the key-bed.

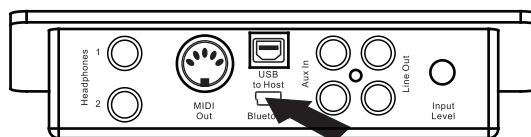

2). Press the [STANDBY/ON] button to turn the piano on. The blue indicator light on the Bluetooth receiver will flash.

3). Press [FUNCTION] button repeatedly to select "Other Setting?". Press [GROUP▲/▼] button repeatedly to select "Bluetooth?", Press [DATA▲/▼] button to select On or Off.

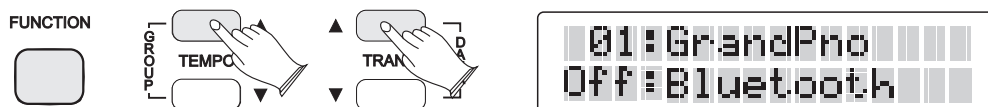

On----- Turn on the Bluetooth function.

Off----- Turn off the Bluetooth function.

4). You will find the receiver as an option on your Bluetooth device's settings, select the bluetooth form your device to connect. When the receiver has successfully connected the blue indicator light on the receiver will remain on.

Use your Bluetooth device to access the information that you want to hear through the piano.

The keyboard is available for playing while the recording is playing back. Play along with your favourite band!

5). Use the Function Bluetooth menu again to turn Bluetooth off.

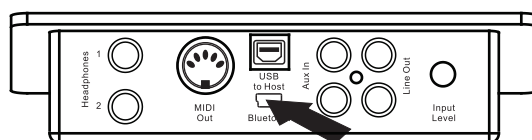

#### **NOTE**

Bluetooth devices should be placed near and in direct view of the Bluetooth receiver when initially set up. The distance and strength of the signal will depend on environmental conditions. Please make sure the volume of the piano and the Bluetooth device is turned up. If you are unable to connect to your Bluetooth device, please make sure that any other previously connected device has been disconnected.

If you are still unable to connect, please turn the Bluetooth function on your device off, and then back on to attempt to connect. To change Bluetooth devices during normal operation disconnect the first Bluetooth and then reconnect to the new device following the above instructions. Please also note, due to differences in Bluetooth technology, some Bluetooth enabled devices maybe incompatible, function improperly, or may not support all features when used with the wireless receiver.

#### Troubleshooting

Please make sure the volume of the piano and the Bluetooth device is turned up. If you are unable to connect to your Bluetooth device, please make sure that any other previously connected device has been disconnected. If you are still unable to connect, please turn the Bluetooth function on your device off, and then back on to attempt to connect. To change Bluetooth devices during normal operation disconnect the first Bluetooth and reconnect to the new device following the above instructions.

# MIDI Functions

If you are an advanced MIDI user, this section will help you to access the MIDI controller capabilities of the piano. If you already know that you need this specialized functionality, then this section is for you. However, this information is not necessary in order to enjoy playing the piano. A good rule to keep in mind is: If you don't know what a function described in this section is, then you probably don't need it.

MIDI, or Musical Instrument Digital Interface, is the way most electronic keyboards communicate with computers and with each other. Through a series of MIDI messages a computer or keyboard can tell an instrument what note to play, how loud to play it, when to stop playing it, and a host of other information.

The piano can send MIDI information to a computer or another MIDI-capable instrument, via its MIDI or USB output.

## MIDI In

**Reference:** Function "MIDI IN"(P.31).

## MIDI Out Track

**Reference:** Function "MIDI OUT"(P.31).

## Local ON/OFF

**Reference:** Function "ALL LOCAL"(P.30).

# Factory Reset

1. Turn off the power.



2. Hold [DATA ▲/▼] buttons, then turn the power on.  
It can restore all internal settings to factory set.

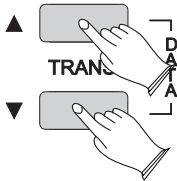

# Appendix

## Percussion Voice List

Note#	Note	Standard(0)	Room(8)	Power(16)	Electronic(24)	Synth(25)	Dance(26)	Jazz(32)	Brush(40)	Classic(48)	Drum(56)	Effects(56)
24	C	Seq Click H	←	←	←	←	←	←	←	←	←	
25	#C	Brush Tap	←	←	←	←	←	←	←	←	←	
26	D	Brush Swirl L	←	←	←	←	←	←	←	←	←	
27	#D	Brush Slap	←	←	←	←	←	←	←	←	←	
28	E	Brush Swirl H	←	←	Reverse Cymbal	Reverse Cymbal	←	←	←	←	←	
29	F	Snare Roll	←	←	←	←	←	←	←	←	←	
30	#F	Castanet	←	←	Hi-Q	Hi-Q	←	←	←	←	←	
31	G	Snare L	←	SD Elec M	Snare L	SD Elec H2	←	Snare Jazz	Brush Slap L	←	Snare H Soft 2	
32	#G	Sticks	←	←	←	←	←	←	←	←	←	
33	A	Bass Drum L	←	←	←	←	←	←	←	←	Bass Drum L3	←
34	#A	Open Rim Shot	←	←	←	←	Dance 1	←	←	←	Open Rim Shot 2	
35	B	Bass Drum M	←	←	BD Rock	BD Analog 1L	Dance Kick	←	←	Gran Casa	←	
36	C	Bass Drum H	←	←	BD Rock 2	BD Analog 1H	Dance 2	BD Jazz	BD Jazz	Gran Casa Mute	Bass Drum H 2	
37	#C	Slide Stick	←	←	←	Analog Slide Stick	Dance 3	←	←	←	←	
38	D	Snare M	SD Room L	SD Rock	SD Elec M	SD Analog 1H	Dance Snare 1	SD Jazz L	Brush Slap H	Marching SD M	Snare L2	
39	#D	Hand Clap	←	←	←	←	Dance 4	←	←	←	←	High-Q
40	E	Snare H	SD Room H	SD Rock Rim	SD Elec H	SD Analog 1L	Dance Snare 2	SD Jazz H	Brush Tap	Marching SD H	Snare H Hard 2	Slap
41	F	Floor Tom L	Room Tom 1	Room Tom 1	E Tom 1	Analog Tom 1	Dance Tom 1	←	Brush Tom 1	←	←	Scratch Push
42	#F	Hi-Hat Closed	←	←	←	Analog HH Closed1	Dance Hita 1	←	←	←	←	Scratch Pull
43	G	Floor Tom H	Room Tom 2	Room Tom 2	E Tom 2	Analog Tom 2	Dance Tom 2	←	Brush Tom 2	←	←	Sticks
44	#G	Hi-Hat Pedal	←	←	←	Analog HH Closed2	Dance Hita 2	←	←	←	←	Square Click
45	A	Low Tom	Room Tom 3	Room Tom 3	E Tom 3	Analog Tom 3	Dance Tom 3	←	Brush Tom 3	←	←	Mtrm .Click
46	#A	Hi-Hat Open	←	←	←	Analog HH 1 Open	Dance Hita 3	←	←	←	←	Mtrm. Bell
47	B	Mid Tom L	Room Tom 4	Room Tom 4	E Tom 4	Analog Tom 4	Dance Tom 4	←	Brush Tom 4	←	←	Gl.FretNoiz
48	C	Mid Tom H	Room Tom 5	Room Tom 5	E Tom 5	Analog Tom 5	←	←	Brush Tom 5	←	←	Gl.CutNoise
49	#C	Crash Cymbal 1	←	←	←	Analog Cymbal	Dance Cha 1	←	←	Hand Cym L Open	←	Gl.CutNoise
50	D	High Tom	Room Tom 6	Room Tom 6	E Tom 6	Analog Tom 6	←	←	Brush Tom 6	←	←	String Slap
51	#D	Ride Cymbal 1	←	←	←	←	←	←	←	Hand Cym L Closed	←	Fl.KeyClick
52	E	Chinese Cymbal	←	←	←	←	←	←	←	←	←	Laughing
53	F	Ride Cymbal Clo	←	←	←	←	←	←	←	←	←	Screaming
54	#F	Tambouline	←	←	←	←	Dance Ling	←	←	←	←	Punch
55	G	Splash Cymbal	←	←	←	←	←	←	←	←	←	Heart Beat
56	#G	CowBell	←	←	←	Analog Cowbell	←	←	←	←	←	Footsteps 1
57	A	Crash Cymbal 2	←	←	←	←	Dance Cha 2	←	←	Hand Cym H Open	←	Footsteps 2
58	#A	Vibraslap	←	←	←	←	←	←	←	←	←	Applause
59	B	Ride Cymbal 2	←	←	←	←	←	←	←	Hand Cym H Closed	←	Door Creaking
60	C	Bongo H	←	←	←	←	←	←	←	←	←	Door
61	#C	Bongo L	←	←	←	←	←	←	←	←	←	Scratch
62	D	Conga H Mute	←	←	←	Analog Conga H	←	←	←	←	←	Wind Chimes
63	#D	Conga H Open	←	←	←	Analog Conga M	←	←	←	←	←	Car-Engine
64	E	Conga L	←	←	←	Analog Conga L	←	←	←	←	←	Car-Stop
65	F	Timbale H	←	←	←	←	←	←	←	←	←	Car-Pass
66	#F	Timbale L	←	←	←	←	←	←	←	←	←	Car-Crash
67	G	Agogo H	←	←	←	←	←	←	←	←	←	Siren
68	#G	Agogo L	←	←	←	←	←	←	←	←	←	Train
69	A	Cabasa	←	←	←	←	←	←	←	←	←	Jetplane
70	#A	Maracas	←	←	←	Analog Maracas	Dance 5	←	←	←	←	Helicopter
71	B	Samba Whistle H	←	←	←	←	Dance 6	←	←	←	←	Starship
72	C	Samba Whistle L	←	←	←	←	Dance 7	←	←	←	←	Gun Shot
73	#C	Cairo Short	←	←	←	←	Dance 8	←	←	←	←	Machine Gun
74	D	Cairo Long	←	←	←	←	Dance 9	←	←	←	←	Lasergun
75	#D	Claves	←	←	←	Analog Claves	Dance 10	←	←	←	←	Explosion
76	E	Wood Block H	←	←	←	←	←	←	←	←	←	Dog
77	F	Wood Block L	←	←	←	←	Dance 11	←	←	←	←	HorseGallop
78	#F	Guica Mute	←	←	Scratch Push	Scratch Push	Dance 12	←	←	←	←	Bird
79	G	Guica Open	←	←	Scratch Pull	Scratch Pull	←	←	←	←	←	Rain
80	#G	Triangle Mute	←	←	←	←	←	←	←	←	←	Thunder
81	A	Triangle Open	←	←	←	←	Dance 13	←	←	←	←	Wind
82	#A	Shaker	←	←	←	←	Dance 14	←	←	←	←	Seashore
83	B	Jingle Bell	←	←	←	←	←	←	←	←	←	Stream
84	C	Bell Tree	←	←	←	←	Dance Ps3	←	←	←	←	Bubble

# Voice List

NO.	PROGRAM CHANGE	BANK	VOICE NAME
Piano			
01	0	0	AcousticGrandPiano
02	1	0	BrighAcousticPiano
03	2	0	ElectricGrandPiano
04	3	0	Honky-TonkPiano
05	4	0	ElectricPiano1
06	5	0	ElectricPiano2
07	6	0	Harpichord
08	7	0	Clavi
Chromatic Percussion			
09	8	0	Celesta
10	9	0	Glockenspiel
11	10	0	MusicBox
12	11	0	Vibraphone
13	12	0	Marimba
14	13	0	Xylophone
15	14	0	TubularBells
16	15	0	Dulcimer
Organ			
17	16	0	DrawbarOrgan
18	17	0	PercussiveOrgan
19	18	0	RockOrgan
20	19	0	ChurchOrgan
21	20	0	ReedOrgan
22	21	0	Accordion
23	22	0	Harmonica
24	23	0	TangoAccordion
Guitar			
25	24	0	AcousticGuitar(Nylon)
26	25	0	AcousticGuitar(Steel)
27	26	0	ElectricGuitar(Jazz)
28	27	0	ElectricGuitar(Clean)
29	28	0	ElectricGuitar(Muted)
30	29	0	OverdrivenGuitar
31	30	0	DistortionGuitar
32	31	0	GuitarHarmonics
Bass			
33	32	0	AcousticBass
34	33	0	FingerBass
35	34	0	PickBass
36	35	0	FretlessBass
37	36	0	SlapBass1
38	37	0	SlapBass2
39	38	0	SynthBass1
40	39	0	SynthBass2
Strings			
41	40	0	Violin
42	41	0	Viola
43	42	0	Cello
44	43	0	Contrabass
45	44	0	TremoloStrings
46	45	0	PizzicatoStrings
47	46	0	OrchestralHarp
48	47	0	Timpani
Ensemble			
49	48	0	StringsEnsemble1
50	49	0	StringsEnsemble2

NO.	PROGRAM CHANGE	BANK	VOICE NAME
51	50	0	Synth Strings 1
52	51	0	Synth Strings 2
53	52	0	Choir Aahs
54	53	0	Voice Oohs
55	54	0	Synth Voice
56	55	0	Orchestra Hit
Brass			
57	56	0	Trumpet
58	57	0	Trombone
59	58	0	Tuba
60	59	0	Muted Trumpet
61	60	0	French Horn
62	61	0	Brass Section
63	62	0	Synth Brass 1
64	63	0	Synth Brass 2
Reed			
65	64	0	Soprano Sax
66	65	0	Alto Sax
67	66	0	Tenor Sax
68	67	0	Baritone Sax
69	68	0	Oboe
70	69	0	English Horn
71	70	0	Bassoon
72	71	0	Clarinet
Pipe			
73	72	0	Piccolo
74	73	0	Flute
75	74	0	Recorder
76	75	0	Pan Flute
77	76	0	Blown Bottle
78	77	0	Shakuhachi
79	78	0	Whistle
80	79	0	Ocarina
Synth Lead			
81	80	0	Lead 1 (Square)
82	81	0	Lead 2 (Sawtooth)
83	82	0	Lead 3 (Calliope)
84	83	0	Lead 4 (Chiff)
85	84	0	Lead 5 (Charang)
86	85	0	Lead 6 (Voice)
87	86	0	Lead 7 (Fifth)
88	87	0	Lead 8 (Bass+Lead)
Synth Pad			
89	88	0	Pad 1 (New Age)
90	89	0	Pad 2 (Warm)
91	90	0	Pad 3 (Polysynth)
92	91	0	Pad 4 (Choir)
93	92	0	Pad 5 (Bowed)
94	93	0	Pad 6 (Metallic)
95	94	0	Pad 7 (Halo)
96	95	0	Pad 8 (Sweep)
Synth Effects			
97	96	0	Fx 1 (Rain)
98	97	0	Fx 2 (Soundrack)
99	98	0	Fx 3 (Crystal)
100	99	0	Fx 4 (Atmosphere)
101	100	0	Fx 5 (Brightness)

NO.	PROGRAM CHANGE	BANK	VOICE NAME
102	101	0	Fx 6 (Goblins)
103	102	0	Fx 7 (Echoes)
104	103	0	Fx 8 (Sci-Fi)
Ethnic			
105	104	0	Sitar
106	105	0	Banjo
107	106	0	Shamisen
108	107	0	Koto
109	108	0	Kalimba
110	109	0	Bagpipe
111	110	0	Fiddle
112	111	0	Shanai
Percussive			
113	112	0	Tinkle Bell
114	113	0	Agogo
115	114	0	Steel Drums
116	115	0	Woodblock
117	116	0	Taiko Drum
118	117	0	Melodic Tom
119	118	0	Synth Drum
120	119	0	Reverse Cymbal
Sound Effects			
121	120	0	Guitar Fret Noise
122	121	0	Breath Noise
123	122	0	Seashore
124	123	0	Bird Tweet
125	124	0	Telephone Ring
126	125	0	Helicopter
127	126	0	Applause
128	127	0	Gunshot
Piano			
129	4	98	DetunedEP1
130	5	98	DetunedEP2
131	6	98	CoupledHarpichord
132	14	98	Dulcimer
Organ			
133	16	98	DetunedOrgan 1
134	17	98	Percussive Organ
135	19	98	Reed Organ
136	21	98	Harmonica 1
Guitar			
137	24	98	Steel Guitar
138	25	90	StringGuitar
139	25	98	Jazz Guitar
140	26	98	Clean Guitar
141	27	98	Muted Guitar
142	28	98	Overdriven Guitar
143	30	98	Guitar Harmonics
Bass			
144	31	98	Acoustic Bass 1
145	38	98	SynthBass
Strings			
146	39	98	Violin 1
147	40	98	Viola
Ensemble			
148	48	98	Synth Strings 1
149	50	98	Choir Aahs





## MIDI Implementation Chart

Function	Transmitted	Recognized	Remarks
Basic Default	(*1)	1-16CH	
Channel Changed	(*1)	1-16CH	
Mode Default	Mode 3	Mode 3	
Messages Altered	X *****	X X	
Note Number : True voice	0~127 *****	0~127 0~127	
Velocity Note ON	O 9nH,v=1~127	O 9nH,v=1~127	
Note OFF	O 9nH,v=0 or 8nh	O 9nH,v=0 or 8nh	
Affter Key's	X	X	
Pitch Bender	X	O	
Control Change	O	O	Bank Select
0,32	X	O	Modulation
1	X	O	Portamento time
5	O	O	Data Entry
6	O	O	Volume
7	O	O	Pan
10	X	O	Expression
11	O	O	Sustain
64	X	O	Portamento
65	O	O	Sostenuto
66	O	O	Soft pedal
67	O	O	DSP TYPE
80,81	O	O	DSP DEPTH
91,93	O	O(*2)	RPN LSB,MSB
100,101	O	O	All sound off
120	X	O	Reset all Controllers
121	O	O	Local control
122	O	O	
Program Change : True	O 0-127 0-127	O 0-127 0-127	
System Exclusive	X	O	
System : Song Position	X	X	
: Song Select	X	X	
Common : Tune	X	X	
Aux : Local on/off	O	O	
: All Notes Off	O	O	
Messages : Active Sense	X	O	
: Reset	X	O	

Mode1:OMNI ON,POLY    Mode2:OMNI ON,MONO    O: Yes  
 Mode3:OMNI OFF,POLY    Mode4:OMNI OFF,MONO    X: NO

\*1: Main voice track (01-16).Default: 01  
 Split voice track (01-16).Default: 02  
 Dual voice track (01-16).Default: 03  
 Percussion track (01-16).Default: 10

\*2: Registered parameter number:  
 #0: Pitch sensivity  
 #1: Fine tuning cents  
 #2: Coarse tuning in half-tones

## Troubleshooting Hints

<ul style="list-style-type: none"> <li>When the instrument is turned on or off, a Popping sound is temporarily produced.</li> </ul>	<p>This is normal and indicates that the instrument is receiving electrical power.</p>
<ul style="list-style-type: none"> <li>When using a mobile phone, noise is produced. Using a mobile phone in close proximity to the instrument may produce interference.</li> </ul>	<p>To prevent this, turn off the mobile phone or use it further away from the instrument.</p>
<ul style="list-style-type: none"> <li>Not all of the voices seem to sound, or the sound seems to cut off.</li> </ul>	<p>The instrument is polyphonic up to a maximum of 64 notes — including Dual voice, Split Voice, auto accompaniment, song, and Metronome. Notes exceeding this limit will not sound.</p>
<ul style="list-style-type: none"> <li>The Auto Accompaniment does not sound properly.</li> </ul>	<p>Make sure that the Auto Accomp Volume Function is set to an appropriate level. Is the Split Point set to an appropriate key for the chords you are playing? Set the Split Point to an appropriate position on the keyboard.</p>
<ul style="list-style-type: none"> <li>No sound produced by the keyboard, but the lights and screen work.</li> </ul>	<p>Check that the master volume control is not set to minimum. Check that nothing is plugged into the headphone socket.</p>
<ul style="list-style-type: none"> <li>The sound of the voice changes from note to note.</li> </ul>	<p>This is normal. The digital tone generation uses multiple recordings (samples) of an instrument across the range of the keyboard; The actual sound of the voice may be slightly different from note to note.</p>
<ul style="list-style-type: none"> <li>The volume is too soft.</li> <li>The sound quality is poor.</li> <li>The rhythm stops unexpectedly or will not play.</li> <li>The recorded data of the song, etc. does not play correctly.</li> <li>The LED display suddenly goes dark, and all panel settings are reset.</li> </ul>	<p>If you have lost or damaged your AC adaptor, please contact your nearest store for a correct replacement adaptor. An incorrect AC mains adaptor which is not rated sufficiently can cause malfunction or damage.</p>
<ul style="list-style-type: none"> <li>To completely restore all settings as per factory settings.</li> </ul>	<p>Perform a factory reset, Please refer to content in this owner's manual. All of the user setting will be erased and the default factory settings will be applied to the instrument.</p>
<ul style="list-style-type: none"> <li>Power suddenly and unexpectedly turns off, after a period of not touching the keys.</li> </ul>	<p>This is normal and the Auto Power Off function may have been activated. If you need to disable the Auto Power Off function, please see how to do this in the owner's manual.</p>
<ul style="list-style-type: none"> <li>The sustain pedal or footswitch seems to produce the opposite effect. Example pressing the footswitch deactivates the sustain, and releasing the footswitch triggers the sustain.</li> </ul>	<p>The polarity of the footswitch needs to be correctly detected. Make sure the jack plug for the footswitch is connected. Switch the instrument on whilst not touching the pedal.</p>

## Specifications

Keyboards	88 Keys with Touch Response
Display	LCD display
Polyphony	64 Note Polyphonic
Voices	200
Voice Control	Volume, Transpose, Pan, Octave, Dual
Pedal	Sustain Pedal, Soft Pedal, Sostenuto Pedal
Effect	8 Reverb Types and Reverb Level 8 Chorus Types and Chorus Level EQ Bass Fader EQ Treble Fader
Keyboard Control	Split, Twin, 3 Touch Sensitivity and Fixed Touch Response
Song	71 songs (Include 55 Learning songs)
Record and Play	2 tracks of record and playback without USB DISK Songs and Registration Files can be saved to USB DISK
Registration Memory	1 x 8
Others	Metronome:(1/4, 2/4, 3/4, 4/4, 5/4, 6/4, 3/8, 6/8, 7/8, 9/8, 12/8) Tempo: 20-280 USB MIDI via USB port Play/Record Audio with Computer via USB port Auto Power Off
Interface	DC, MIDI Out, Line Out , Aux In , Input Level USB to Host, Bluetooth, Pedal, 2 Headphones
Speakers	Tweeter: 20W/6ohm*2, 5W/4ohm*2 Middle: 15W/4ohm*2 Woofer: 25W/6ohm*2
Dimensions (W x D x H )	1416mm*1210mm*870mm
Weight	127Kg

# Assembly Instructions

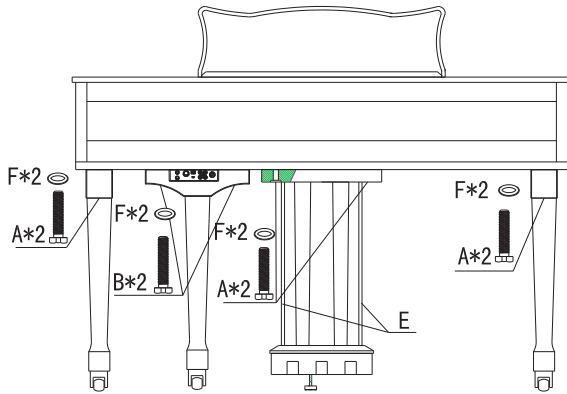

- A: X6 M12X50
- B: X2 M12X70
- C: X8 ST3.9X12
- D:
- E: X2
- F: X8 D=12

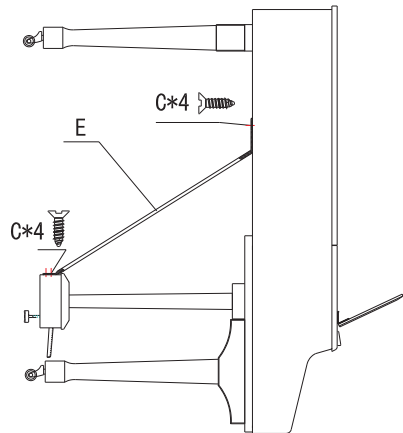
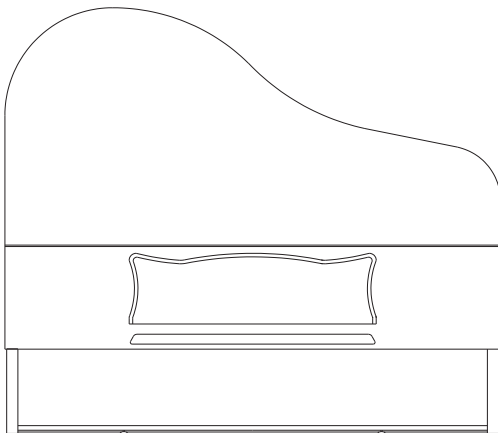

**Turn the adjustable Pedal Board support, until it is in firm contact with the floor.**

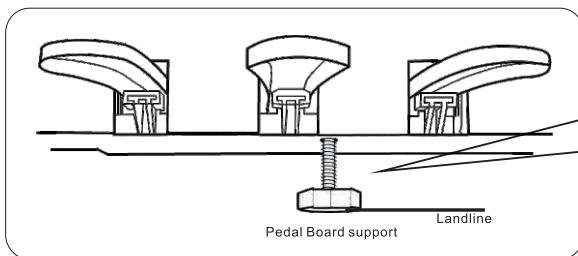

Before moving the piano to a new location, always remember to raise the level of the Pedal Board support so that it is not touching the floor. Once the piano is in place, you can adjust it so it is in firm contact with the floor again.



## DECLARATION

**1511002**

This certificate is issued by **FATAR Srl** having principal place of business in Via Volponi - Zona Industriale Squartabue, 62019 Recanati (MC) – ITALY.

Brand:

**RINGWAY GRAND DIGITAL PIANO**

Models:

**GDP6300, GDP6320, GDP6500, GDP6800**

Object:

**We certify that the products listed above use the keyboard mechanism denominated TP/40GH, developed and produced by FATAR in accordance with its quality standards.**

The keyboard TP/40GH has been developed to offer a solid and professional touch, providing an authentic and precise performance. The four zones of graded hammer action and the return spring application create the right combination to give the feeling of a real acoustic piano.

The use of this keyboard mechanism in association with the products here certified can be identified through the logo "**FATAR GRAND TOUCH**".



Place and date of issue: Recanati - ITALY, 8th April 2015

**FEDERICA CELLI**  
Sales Manager

**MARCO RAGNI**  
President

**NOTE:**

The use of logo "FATAR GRAND TOUCH" in its different multimedia formats is allowed only and exclusively in association with the products listed in this certificate. Any other use is punishable by the law.

FATAR ® is a registered trademark and all rights are reserved.