

USER MANUAL

GEWA Digital Piano **UP365**



Bedienungsanleitung | User manual | Mode d'emploi | Manual de instrucciones
www.gewakeys.com



Read these operating instructions before use and observe the safety information!
Keep the instruction manual for future reference.

Manufacturer:
GEWA music GmbH
Werkstraße 1
08626 Adorf
GERMANY

www.gewakeys.com

Version 1.0

Last update: 11.04.2021

1	SAFETY INFORMATION	5
1.1	Key	5
1.2	Intended use	6
1.3	Improper use	6
1.4	Precautions	7
1.5	CE mark	8
1.6	Disposal	8
2	DELIVERY	9
3	ASSEMBLY INSTRUCTIONS	10
3.1	Opening the keyboard lid	11
3.2	Use with a keyboard stand	12
4	FIRST STEPS	12
4.1	Control elements of your digital piano	12
4.1.1	Function Keys	13
4.1.2	Pedals	14
4.2	Keyboard Connections	15
5	OPERATING USE	17
5.1	Switching on	17
5.2	DEMO function	17
5.3	Sound selection	18
5.3.1	Sound combination: Dual Sound	19
5.3.2	Sound combination: Split Sound	20
5.3.3	Sound combination: 4Hand Mode	21
5.4	Effects	22
5.4.1	Reverb	22
5.4.2	Chorus and other effects	23
5.5	Metronome	24
5.6	Player	25
5.6.1	USB Player	25
5.6.2	Lessons	26
5.6.3	DEMO function	26
6	FUNCTIONS MENU	26
6.1	Table of Settings	27
6.2	General Settings	28
6.2.1	Brilliance	28
6.2.2	Key Transpose	28
6.2.3	Tuning	29
6.2.4	Max Phones Volume	29
6.2.5	Input Volume	29
6.2.6	Input Reverb	29
6.2.7	Start-Up Settings	30
6.2.8	Piano Information	30
6.3	Piano Settings	31
6.3.1	Keyboard Response	31
6.3.2	Damper Pedal	32
6.3.3	Una Corda Level	32

6.3.4 Sympathetic Resonance	32
6.3.5 Temperament	33
6.3.6 Root Note	33
6.4 USB	34
6.5 System	34
6.5.1 Display Settings	35
6.5.2 Auto Power Off	35
6.5.3 Registrations Restore	35
6.5.4 Default Restore	35
6.6 MIDI Settings	36
6.6.1 MIDI Transmission Channel	36
6.6.2 Local Control	36
6.6.3 Program Change	37
6.6.4 Piano Mode	37
6.7 Bluetooth Settings.....	37
6.7.1 Bt. Audio Vol	38
6.7.2 Bluetooth	38
6.7.3 Bluetooth Audio	38
6.7.4 Bluetooth MIDI	38
7 USER SETTINGS	39
7.1 Registration of settings	39
7.2 Applying registrations	39
8 RECORDER AND PLAYBACK	40
8.1 Recording songs	40
8.1.1 Recording with metronome support.....	40
8.2 Playing back recordings	41
8.3 Editing recordings	42
8.4 Loop	42
9 KEYBOARD USER CALIBRATION	43
9.1 Entering the calibration mode	43
9.2 Creating a user calibration	43
9.3 Comparing factory and user calibration	44
9.4 Saving and deleting the user calibration	44
9.5 Exiting the calibration mode	44
10 CONNECTING EXTERNAL DEVICES	45
10.1 Connecting Headphones	45
10.2 Connecting a playback device	45
10.3 Connecting an amplifier	45
10.4 Connecting to PC	45
10.5 Bluetooth Audio	46
11 USEFUL INFORMATION	47
11.1 INDEX	47
11.2 Warranty	48
12 TROUBLESHOOTING	48
13 TECHNICAL SPECIFICATIONS	49

Dear Customer,

Thank you for choosing a digital piano from GEWA music!

You have chosen a high-quality digital piano that will give you an impressive sound experience and lots of fun.

Additional functions extend the capabilities of your digital piano far beyond piano playing.

Your safety is very important to us!

Please read the safety information carefully and pay close attention to it. Retain this manual and hand it over to the respective user.

1

SAFETY INFORMATION



NOTE





The manufacturer is not liable for personal injury or property damage resulting from improper use of the device!

Only use your digital piano as directed!

1.1

KEY

The following symbols are used in this operating manual to identify hazards and notes.

Level of danger	Symbol	Importance	Definition
Severe injury		WARNING	Severe to fatal injuries if disregarded
Severe injury through electric shock		WARNING	Additional symbol for danger of electric shock
Slight injury and property damage		CAUTION	Slight injury and / or property damage can occur if the safety instructions are disregarded.
Note		NOTE	Crucial information concerning the handling of the device
Tip		TIP	Application tips

1.2 INTENDED USE

The digital piano is intended for use in dry rooms.

- Devices for audio playback (as input or output) or for data communication can be connected. However, the respective technical specifications must be complied with (see the section "Technical data").
- The electrical connection may only be made to correctly installed power supplies, fulfilling the respective regulations. The mains voltage on the identification plate must correspond to the mains voltage of the country of use.
- The digital piano is only to be used in the original delivery condition described below. Conversions of any kind are not permitted and cause the immediate loss of the warranty claim.
- The digital piano must be placed on securely fastened and weight-suitable, stable and level floors or platforms.

1.3 IMPROPER USE – EXAMPLES:

- Use outdoors or in rain
- Use in damp rooms
- Connection to incorrect supply voltage or improperly installed electrical power supplies.
- Use in close proximity to electrical or electronic equipment such as stereos, televisions, radios or mobile phones.
- These devices may cause interference and affect the sound quality.
- Electrical leads that are too long can also affect sound quality.
- Transport and installation in places or vehicles with strong vibration, dust and strong heat e.g. direct sunlight.

The manufacturer accepts no liability for damage for the following reasons:

- Disregard of the safety instructions
- Improper handling
- Use with devices that are not compatible with the technical data listed below



NOTE

1.4

PRECAUTIONS

Please follow the the precautions listed here. Disregard of precautionary measures can have serious consequences:

- Severe injury or even fatal accidents
- Electric shock
- Short circuit
- Damage
- Fire

Other threats are conceivable; this is not an exhaustive list.



WARNING



Fatal electric shocks

- Even low electrical currents can lead to serious injuries and death.
- Never open the digital piano's casing.
- Never use damaged power cables.
- Lay the power cable in such a way that it can not be damaged.
- Never place containers (vases, glasses etc) filled with water or fluids on the piano.
- Never pour water or liquids on to the digital piano or keyboard.
- Never clean the digital piano with a wet cloth.
- Never plug in or pull out the mains plug with wet hands. Never pull on the cable; it can cause damage.
- If liquid accidentally gets into the digital piano, immediately unplug the power. Then have your digital piano checked by your GEWA service representative.



WARNING

Unusual circumstances

- Turn off the digital piano or unplug the power cable if:
 - There is a sudden loss of sound while using the digital piano
 - The digital piano generates an unusual smell or smoke
- Be sure to have the digital piano checked by your GEWA service representative



WARNING

Protection against fire

- Open flames such as candles or tealights can tip over and cause a fire
- Never place objects with open flames on the digital piano!



CAUTION

Damage to the digital piano

- Inappropriate electrical voltages can damage the digital piano.
- Only operate the digital piano in the permissible voltage range (as indicated on the respective identification plate).
- Only use the supplied power cable.
- Never place the power cable near to sources of heat, such as radiators or freestanding heaters.
- Do not bend or kink the power cable, or damage it in any other way.
- Lay the power cable so that nobody can step on it, trip on it or roll over it.
- Do not place objects on the power cable.
- Regularly check the power cable and remove any dust or dirt that may be present.



CAUTION



Damage to the digital piano through thunderstorms

- Thunderstorms can generate electrical surges that can damage electrical equipment.
- In the event of a thunderstorm or long periods of non-use (such as travel), unplug the appliance from the mains.

1.5



CE MARK

CE MARK

This device complies with EU directive requirements: **Directive 2014/53/EU**

EN55020:2007+A11:2011

EN55024:2010

EN55032:2012

EN61000-3-2:2014

EN61000-3-3:2013

EN301489-17:V2.2.1

EN301489-17:V3.2.0

EN62479:2010

EN300328:V2.1.1

The conformity with the regulations listed above is confirmed by the CE sign on the device. The declaration of conformity can be viewed at the following address:

GEWA music GmbH, Werkstraße 1, 08626 Adorf, GERMANY

1.6

DISPOSAL

To dispose of the old device, please take it to your local waste management authority (e.g. disposal company or recycling centre).



The adjacent symbol indicates that the device must be disposed of separately from household waste. In accordance with the Electrical and Electronic Equipment Act, owners of old appliances are legally required to dispose of old electrical and electronic appliances at a separate and designated waste disposal point.

Please help in contributing to protect the environment by not disposing of the old device in household waste.

2

PARTS SUPPLIED WITH THE PIANO

Check the content of the package for completeness before starting with the assembly.

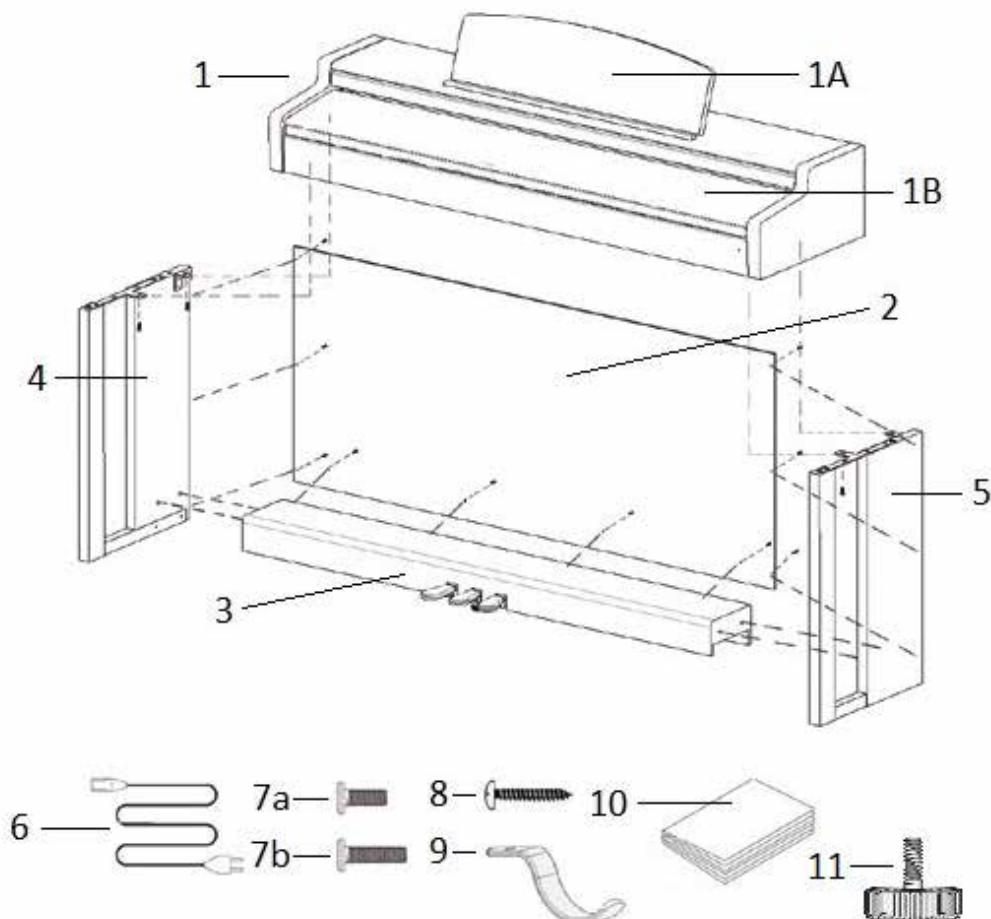

Pos.	Description	Pcs.
1	Keyboard	1
1A	Music desk	1
1B	Rollable keyboard lid	1
2	Rear panel	1
3	Pedal board	1
4	Left side panel	1
5	Right side panel	1
6	Power cable	1
7a	Phillips screw M6 x 16	5
7b	Phillips screw M6 x 30	4
8	Phillips wood screw 3.5 x 30	10
9	Headphone hanger	1
10	Quick Start Guide	1
11	Adjustment screw	1
not shown	Cable clips	2

3

ASSEMBLY INSTRUCTIONS

In this section we will show you how to easily set up your GEWA digital piano.

For the assembly you need:

- size 2 Phillips screwdriver
- second assisting person



NOTE

Do not firmly tighten the recessed head screws until all parts of your digital piano are aligned. Make sure you assemble your digital piano on level ground.

Now lets start assembling your GEWA digital piano:

1. Unfold the pedal cable (not shown) and screw the adjustment screw (11) into the pedal board (3).
2. By using the phillips screws (7b), connect the side panels (4 and 5) to the pedal board.
3. Then attach the rear panel (2) with phillips wood screws (8).
4. Now place the keyboard onto the base from above. Make sure that the angels of the side panels are guided into the millings of the keyboard. Then secure the keyboard with 4 screws (7a).
5. Now screw the headphone hanger (9) onto the left underside of the keyboard by using a phillips screw (7a).
6. Then align your digital piano and tighten all of the screws.

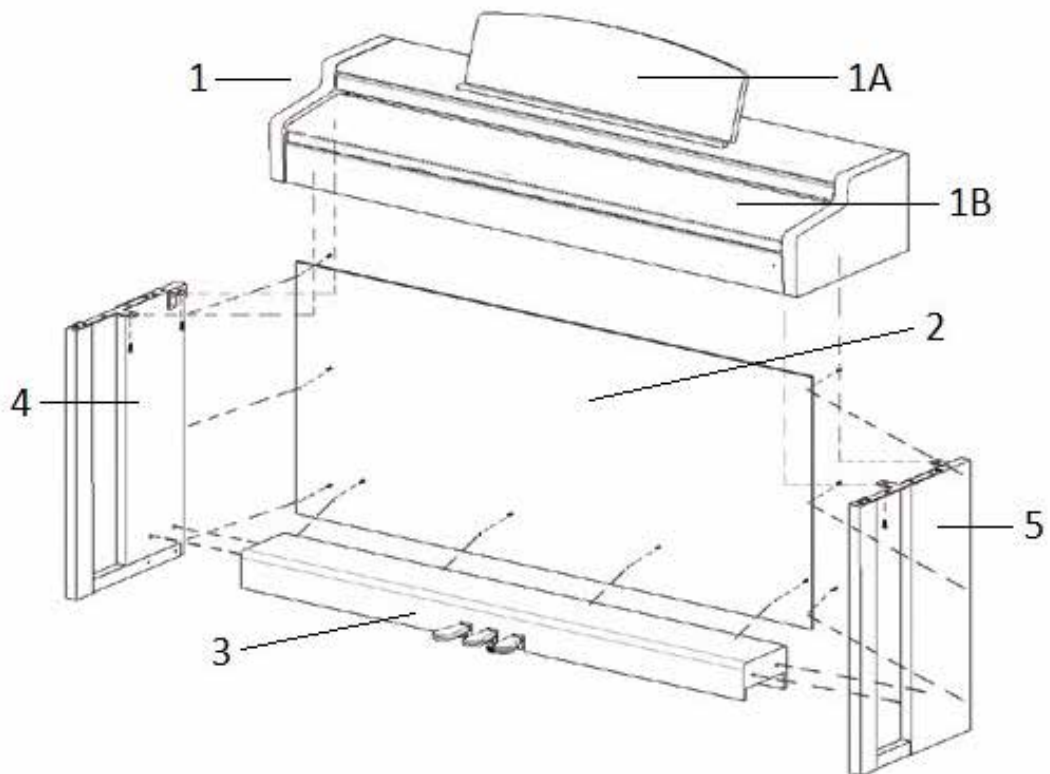

- Place your digital piano at the desired location and make sure that the adjustment screw (11) touches the floor as shown below.

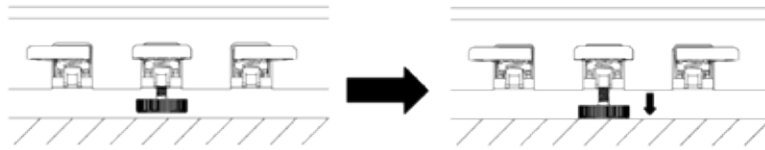

- Insert the pedal cable true to side into the pedal cable socket on the underside of the keyboard (1). It should slide easily into the socket. Then plug the power cable (6) into the power socket which is also located on the underside (not shown).

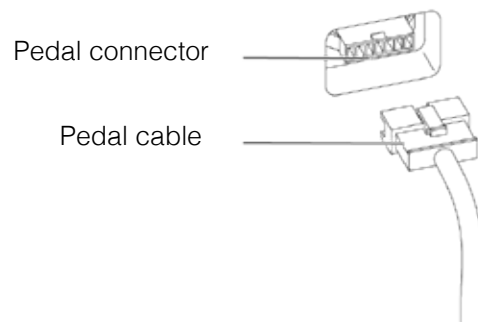

- Set up the music desk as shown below.

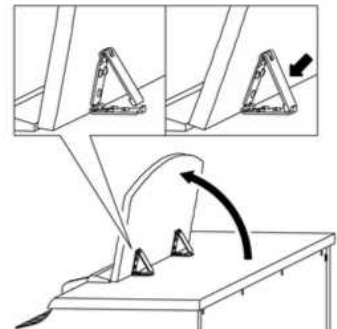

3.1

OPENING THE KEYBOARD LID



CAUTION

Please make sure to always use both hands to open or close the lid.

To open the lid please follow below drawing. In the opposite way the lid can then be closed again

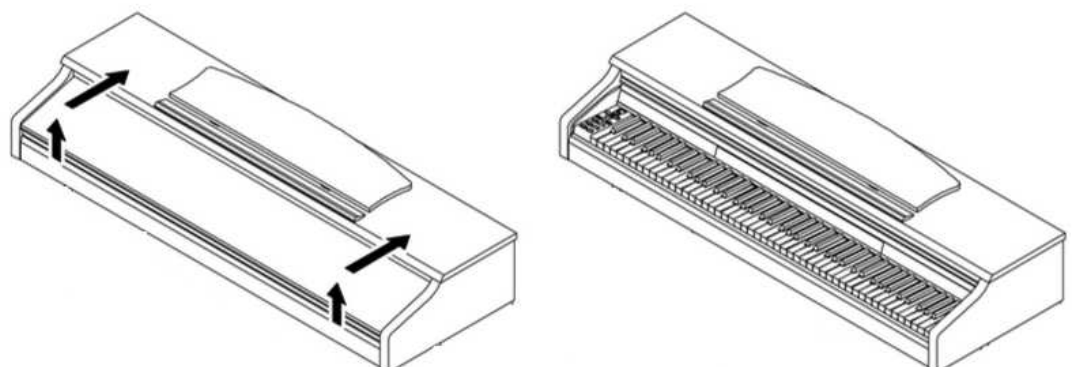

3.2 USE WITH A KEYBOARD STAND



It is also possible to use a keyboard stand instead of the supplied rack. In this case place the keyboard stand on level ground and position the piano centrally on top. If possible, the speakers on the bottom of the piano should not be covered or partly touched by the stand. For the connection with a standard sustain pedal you can use the 6.3mm jack socket labeled 'sustain' on the rear panel.

4 GETTING STARTED

Now let's have a look on to the controls of your GEWA digital piano

4.1 THE CONTROLS OF YOUR DIGITAL PIANO

Your GEWA digital piano features the following controls:

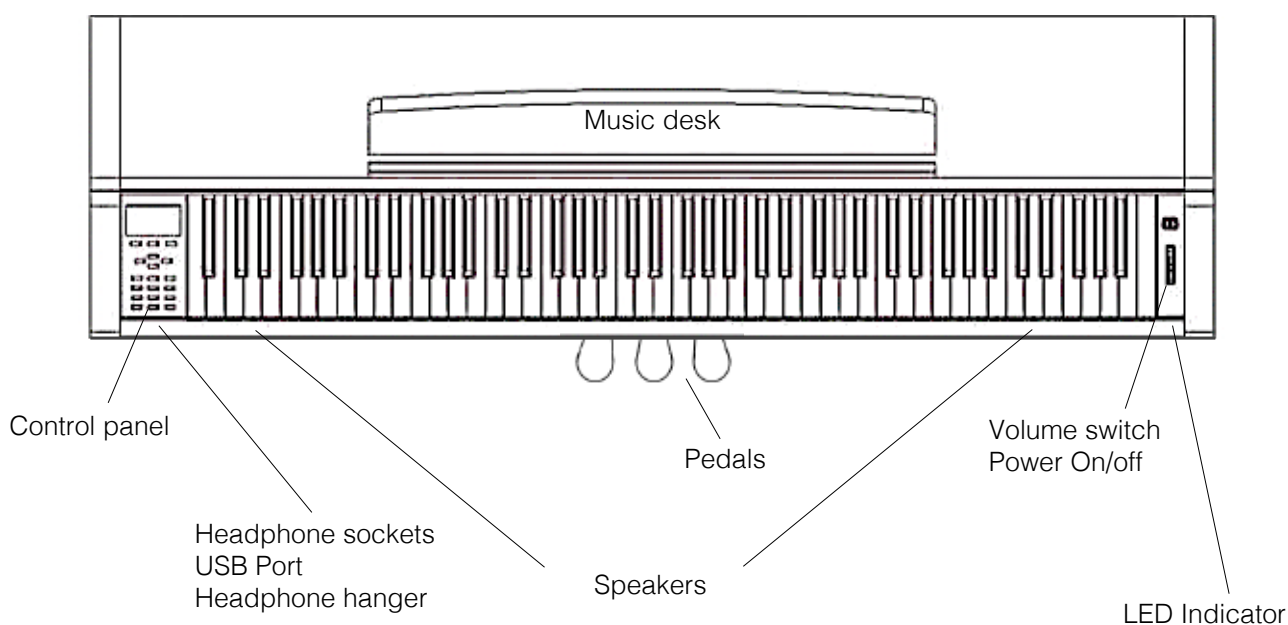

4.1.1 FUNCTION KEYS

Diagram A

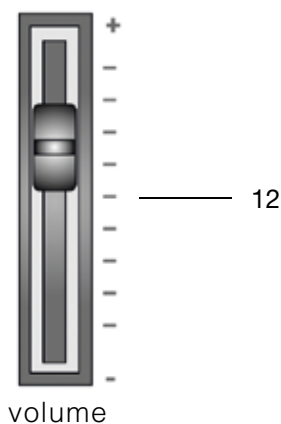
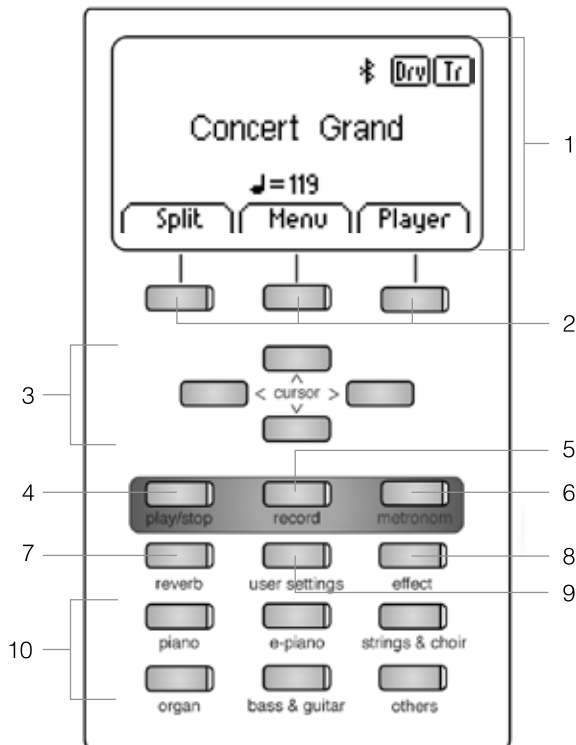

1 Display

Provides settings and status information.



NOTE: The current activated menu is always displayed with a black background.

2 Soft buttons

These allow you to select functions that are shown in the display.

3 Cursor buttons

Navigation to and within functions and function groups

Recording related buttons

4 play/stop

Start / Stop for recorded pieces of music.

5 record

This sets your GEWA Digital Piano to record standby mode

6 Metronome and metronome functions

With this button the metronome can be switched on/off and edited.

7 Reverb button

Turns the reverb on/off and, when longer depressed, enters the edit mode

8 Chorus and other effects

Turns the Chorus and other effects on/off and, when longer depressed, enters the edit mode

9 User settings

In this section you can save and reload your individual settings.

10 Sound selection switches

These switches allow you to select and play the different sounds on your GEWA digital piano.

11 Power On/Off

This switch turns your GEWA digital piano on or off. Press and hold the switch for about 3 seconds to turn off your digital piano.



NOTE: The switch does not engage. Light pressure is enough.

12 Volume switch

This switch determines the volume of your GEWA digital piano.



NOTE: Before switching on, it is advisable to set this control to the middle.

4.1.2 PEDALS

Diagram B

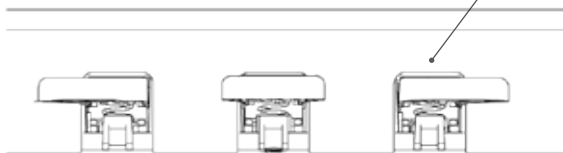

Sustain Pedal (right side)

The Sustain- or Damper Pedal on an acoustic grand piano lifts up all the dampers that sit on the strings. Thereby all played notes continue to sustain after the keys are released.

Furthermore, all the other strings can freely resonate, so their frequencies contribute to a richer sound.

All this is simulated by the pedal of your GEWA piano. It is also possible to play with half pedal, which means the simulated dampers are only lifted slightly, so that the sustaining notes are decaying faster than with the pedal fully depressed.

Sostenuto Pedal (middle position)

The Sostenuto Pedal resembles the Sustain Pedal. The only difference is that only those notes are sustaining whose keys were being depressed at the moment of actuating the pedal. All the other notes are dampened as usual.

Piano Pedal (left side)

When the Piano- or Una Corda Pedal is being operated, the Gewa Piano simulates shifting the keyboard action slightly to the right. The altered striking line of the imaginary piano hammers results in a differently colored tone and a slightly softer volume.

Diagram C

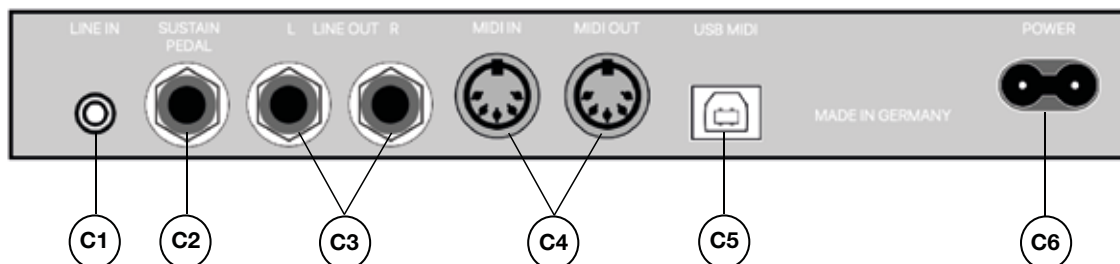

- | | | |
|-----------|-------------------------|---|
| C1 | LINE IN | This port is for external sound source playback (e.g. MP3 players) through the speaker system via a 3.5mm jack socket (-> page 29). |
| C2 | SUSTAIN | You can connect a standard sustain pedal to this 6.3mm jack socket, if you want to use your digital piano with an external stand. |
| C3 | LINE OUT L/R | This connection is split into the stereo channels L(left) and R(right). Using 6.3mm jack cables, you can connect these outputs to a receiver, e.g. an amplifier or a recorder (-> page 43). |
| C4 | MIDI IN/OUT | Connect MIDI devices here (-> pages 36 and 37). |
| C5 | USB-B Connection | Connect your digital piano with your PC via this connection (-> page 43). |
| C6 | Power Supply | Connect your digital piano to the power supply here, using the power cable. |

5

OPERATING USE



NOTE

Any settings, except for the volume control setting, will be reset when your digital piano is turned off. You can change this behaviour and save some of the settings permanently (-> page 30).

5.1

SWITCHING ON



TIP

When switching on, turn the volume switch to the middle position.

1. Press the On/Off switch on the right side of your digital piano.
2. The Reverb and the "Piano" sound group button light up. In addition, the LED indicator lights up on the front right side of your digital piano.
3. Your GEWA digital piano is now ready for use.

5.2

DEMO FUNCTION

The DEMO function provides a fantastic overview of the various sounds of your digital GEWA digital piano.

This is how to activate the DEMO song function:

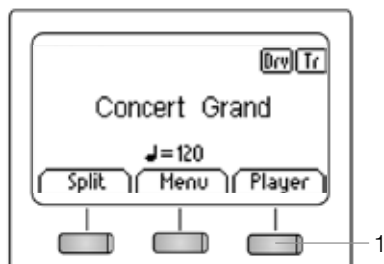

1. Press the soft button that is assigned to "Player" in the display.
2. Use the upper/lower cursor keys to navigate to the „Demo“ Menu. It is highlighted in black when selected.
3. Now press the right cursor key to enter the demo song selection. You can now choose between the following 12 DEMOs:

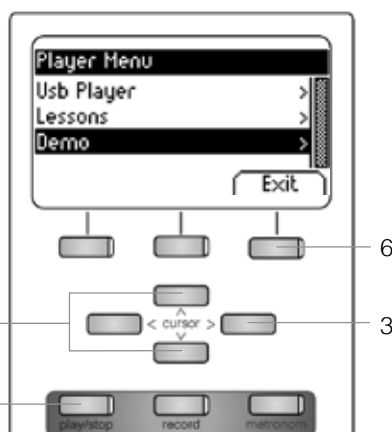

4. Use the upper/lower cursor keys to select the desired DEMO.
5. By pressing the Play / Stop button, the DEMO can be played or stopped.
6. You can leave the Menu by pressing the "Exit" soft button.

5.3 SOUND SELECTION

Your GEWA digital piano features 40 different sounds.
They are arranged in the following groups:

Piano	E-Piano	Strings Choir	Organ	Bass & Guitar	Others
Concert Grand	Seventy Three	Movie Strings	Church Organ 1	Acoustic Bass	Clavi
Bright Grand 1	E-Piano 1	Strings	Church Organ 2	Bass & Cymbal	Vibraphone
Mellow Grand 1	FM Piano	Slow Strings	Draw Bar Organ	Finger E-Bass	Marimba
Mellow Grand 2	Wurly	Pizzicato	Jazz Organ 1	Fretless Bass	Celesta
Upright Piano		Choir	Jazz Organ 2	Picked Bass	French Accord
Rock Grand		Slow Choir	Mellow Organ	Nylon Guitar	
Harpichord		Pop Choir		Steel Guitar	
		Synth Strings			
		OB Saw			
		Dark Pad Synth			
		Synth Bell Pad			

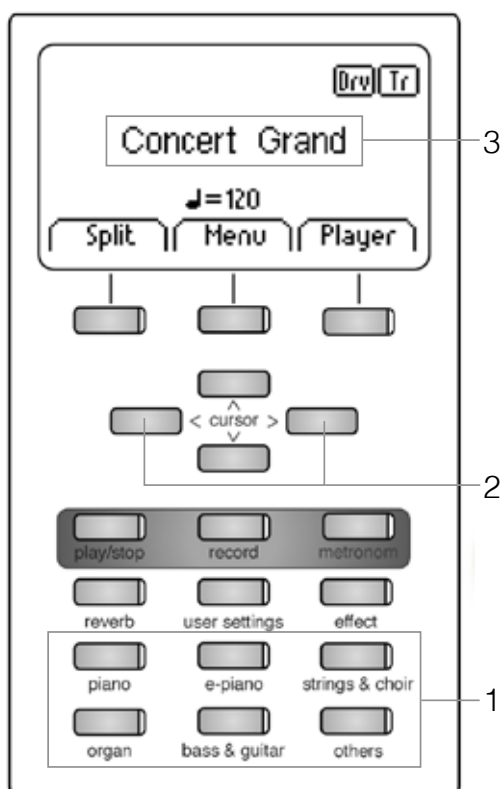

Press the desired sound selection switch (1) repeatedly or press the right/left cursor keys (2) to navigate through the different sounds of the group.

The current selected sound is shown in the display (3).



TIP

Use the demo songs to receive an impression of the different sounds. Let your own playing be inspired by experimenting with the versatile sound groups.

5.3.1 SOUND COMBINATION (DUAL SOUND)

Your GEWA digital piano can be set to play two simultaneous sounds in a layered mode.

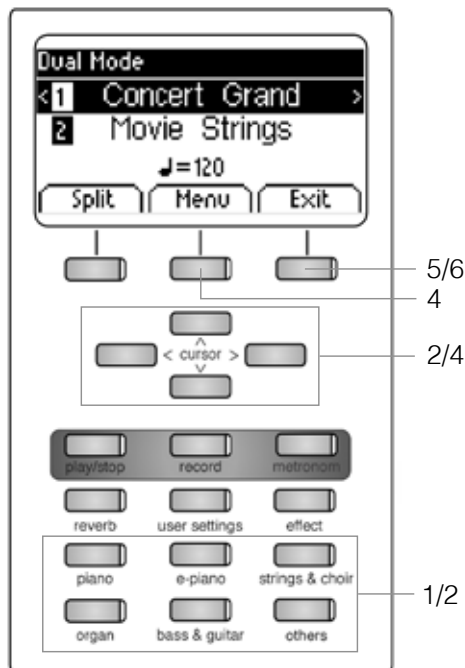

In the following we will show you how to do this:

1. Hold down a sound selection button while selecting a second additional group (e.g. Piano and Strings & Choir).
2. Choose two sounds by using the cursor keys and the sound selection switches (-> page 18).
3. If you now play the keyboard you will hear both sounds simultaneously.

This is how you adjust the Dual Mode:

4. Press the Menu softbutton. Navigate through the following settings and adjust them as desired by using the cursor keys:
 - **Balance:** Here you can change the volume ratio between the two selected sounds.
 - **2_Octave Shift:** With this function, you can transpose the second sound up or down by 1, 2 or 3 octaves.
 - **2_Pedal:** Here you can decide whether the Damper Pedal should sustain both sounds (On) or only the first one (Off).
5. Use the Exit softbutton to leave the menu.
6. Press the Exit softbutton again to deactivate the Dual Mode and to return to the home menu.

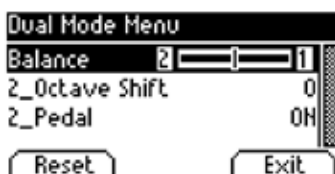

5.3.2 SOUND COMBINATION (SPLIT SOUND)

Your digital piano can be set to play two sounds with a split keyboard (e.g. left part with a bass and right part with a piano sound).

1. Press the Split softbutton. Your keyboard is split into two zones now.
2. By using the cursor keys, select a sound for each zone (-> page 18).
3. Start playing. You will hear one sound for both zones each.

If you want to adjust the Split Mode, proceed as follows:

4. Press the Menu softbutton. Navigate through the following settings and adjust them as desired by using the cursor keys:

- **Split Point:** Here you can define the point where the keyboard is to be split.



TIP Alternatively, you can define the Split Point by holding the “K Sense” softbutton while pressing the desired key on the keyboard.

- **Balance:** Here you can change the volume ratio between the two selected sounds.
- **L_Octave Shift:** With this function, you can transpose the sound chosen for the left side of the split keyboard up or down by 1, 2 or 3 octaves.
- **L_Pedal:** Here you can decide whether the Damper Pedal should sustain both sounds (On) or only the one selected for the right zone of the keyboard (Off).

5. Use the Exit softbutton to leave the menu.
6. Press the Exit softbutton again to deactivate the Split Mode and to return to the home menu.

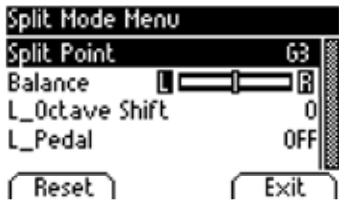
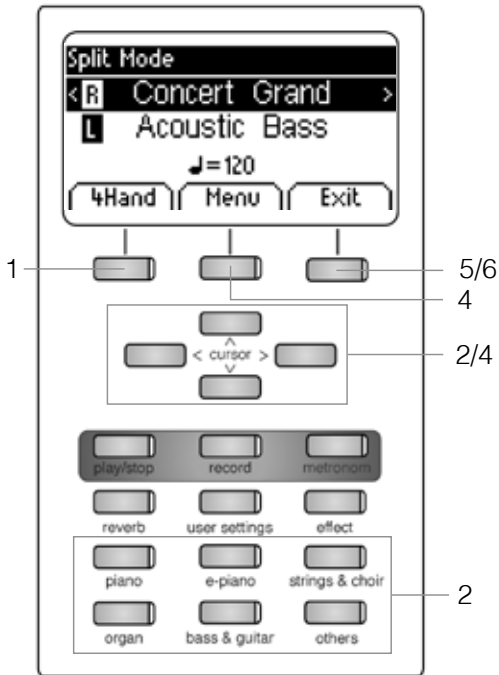

5.3.3 SOUND COMBINATION (4HAND MODE)

Your digital piano can be set to the so-called 4Hand Mode. This mode splits the keyboard into two so that for example teacher and student can play simultaneously in the same octave range. The sound of the left keyboard zone is automatically transposed up by 2 octaves while the sound of the right keyboard zone is transposed down by 2 octaves.

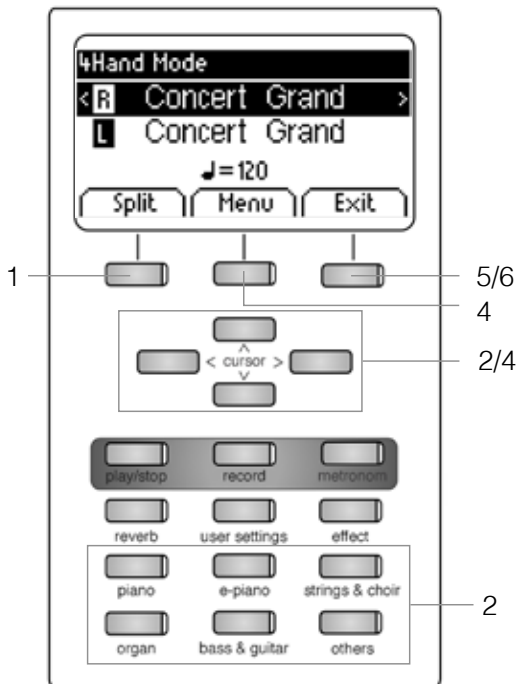

To use the 4Hand Mode, proceed as follows:

1. Press the Split softbutton and then the 4Hand softbutton. Your keyboard is split into two zones which are set as explained.
2. By using the cursor keys, select a sound for each keyboard zone (-> page 18).
3. Start playing. You will hear one sound for each zone as described.

If you want to make further adjustments, proceed as follows:

4. Press the Menu softbutton. Navigate through the following settings and adjust them as desired by using the cursor keys:
 - **Split Point:** Here you can define the point where the keyboard is to be split.
 - **Balance:** Here you can change the volume ratio between the two selected sounds.
 - **R_Octave Shift:** With this function, you can transpose the sound chosen for the right side of the split keyboard up or down by 1, 2 or 3 octaves.
 - **L_Octave Shift:** With this function, you can transpose the sound chosen for the left side of the split keyboard up or down by 1, 2 or 3 octaves.
5. Use the Exit softbutton to leave the menu.
6. Press the Exit softbutton again to deactivate the 4Hand Mode and to return to the home menu.

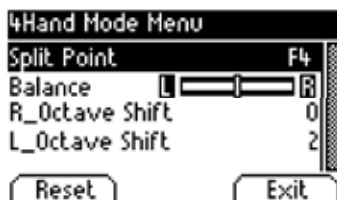

5.4 EFFECTS

Your digital piano has the possibility to add various effects on to the sounds by means of the Reverb and Effect softbutton.

- Some sounds already feature a factory preset reverb or chorus effect making the sound more lively and realistic.
- By pressing the reverb and/or chorus & others button you can deactivate or activate the effects as described.
- The edited effect settings remain active until the digital piano is switched off. When the instrument is switched back on, all factory settings are set back to their factory default values

5.4.1 REVERB

The reverb effect simulates the sound in various room environments.

Your digital piano comes with the following reverb effects:

Display	Simulation
Room 1	a furnished living room
Room 2	a slightly larger space
Stage	a small stage
Hall 1	various types of concert halls
Hall 2	
Hall 3	

To use the reverb effect, proceed as follows:

1. Press the Reverb button to activate or deactivate the effect. When the reverb effect is active, the respective LED lights up. When pressing the softbutton, the reverb type is briefly displayed.



NOTE

Changes of this effect are adopted immediately.

You can make further adjustments to the reverb effect as follows:

2. Hold down the Reverb button until the Reverb Menu opens up. Navigate through the following settings and adjust them as desired by using the cursor keys:

- **Type:** Here you can choose one of the preset reverb styles.
- **Level:** With this setting, you can adjust the volume of the reverb effect in relationship to the selected sound.
- **Time:** Adjust, how long the reverb should last.

3. Use the Exit softbutton to leave the menu.



5.4.2 CHORUS AND OTHER EFFECTS

The effect function contains the following effects:

Name	Description
Chorus	Makes the sound fuller and gives richness to it, as in an ensemble.
Tremolo	Rhythmic influence on the sound volume.
Pan Tremolo	Rhythmic influence on the sound panorama settings (left/right wandering effect). Most suitable for synthetic sounds.
Phaser	Similar to a chorus effect with a slight frequency phase modulation.
Rotary	Rotary speaker cabinet simulation. Suitable for organ sounds.

To use the effect section of your digital piano, proceed as follows:

1. Press the Effect button to turn the effect on or off. When the effect is active, the respective LED lights up. When activating/deactivating the chorus and other effects functions, the corresponding effect is briefly displayed.



NOTE

The change of effects is adopted immediately.

You can make further adjustments to the effects as follows:

2. Hold down the Effect button until the Effects Menu opens up. Navigate through the following settings and adjust them as desired by using the cursor keys:

- **Type:** Here you can choose the desired effect.
- **Dry/Wet:** With this setting, you can adjust the intensity of the effect.
- **Rate:** Here you can define the speed of the modulation.

There is a particular range of settings for the Rotary effect:

- **Speed:** Here you can choose how fast the Rotary effect should work.
- **Drive:** With this setting, you can adjust the intensity of the Rotary effect.

3. Use the Exit softbutton to leave the menu.



5.5 METRONOME

Your digital piano has a built-in metronome that helps you to stay in sync with the music while playing.

The metronome features 8 standard metronomes and 10 more complex accompanying drum beats (see table). It is adjustable between 10 and 400 beats per minute (bpm).

To use the metronome, proceed as follows:

1. Press the Metronome button. The respective LED starts flashing which indicates that the metronome is activated.
2. Press the Metronome button again to deactivate the metronome. The respective LED stops flashing.

To adjust the metronome settings, proceed as follows:

3. Hold down the Metronome button until the Metronome Menu opens up. Navigate through the following settings and adjust them as desired by using the cursor keys:

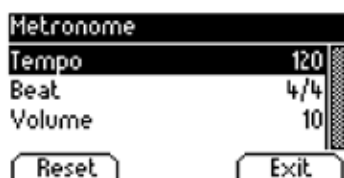

- **Tempo:** Here you can choose the desired metronome speed.
- **Beat/Rhythm:** Here you can select one of the subsequent classic metronome time signatures or one of the accompanying drum beats:

Classic Metronome	Accompanying drum beat
1 / 4	Rock
2 / 4	Swing
3 / 4	Funky
4 / 4	Deep 90's
5 / 4	Kick it
3 / 8	Pop 80's
6 / 8	Blues
12 / 8	Jazz
	Acid
	Lounge

- **Volume:** Here you can define the volume of the metronome.

4. Use the Exit softbutton to leave the menu.



NOTE

Changes are adopted immediately. After switching your GEWA digital piano off, the instrument automatically returns to the original factory settings. (-> page 30)

5.6 PLAYER

You can use the Player to adjust how pieces of music are played back.

5.6.1 USB PLAYER

This menu contains all settings referring to the USB Player function.

Proceed as follows to enter the USB Player:

1. Press the Player softbutton and navigate to the submenu „USB Player“ with the upper/lower cursor keys.
2. Press the right cursor key to enter the menu.
3. By using the upper/lower keys, choose a song from the displayed Playlist and confirm your choice by pressing the Select softbutton.
4. Press the Play / Stop button. The song is now played back. The display shows at which point the playback is at in a bar below the file name.
5. Press the Play / Stop button to stop the playback.

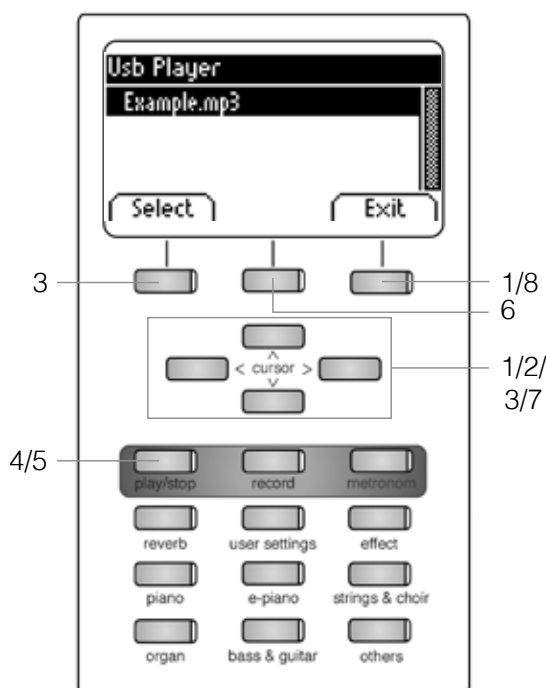

To adjust the USB player further, proceed as follows:

6. Press the Menu softbutton. The following settings appear:
 - **Play Mode:** Different modes of playing back songs are available here.
 - Single Only the chosen song is played back once.
 - Repeat The chosen song is played back in an infinite loop.
 - Repeat All The whole playlist is played back.
 - Random The songs in the playlist are played back in random order.
 - **Song Volume:** Adjust the volume of the song in the ratio to your piano playing.
 - **Key Transpose:** Transpose the keyboard up or down here (-> page 28).
7. Use the right/left cursor keys to set the desired values.
8. Use the Exit softbutton to leave the menu.



5.6.2 LESSONS

This menu grants access to the pieces you can save to your digital piano in a particular lessons format.

To use the Lessons function, proceed as follows:

1. Press the Player softbutton and navigate to the submenu „Lessons“ with the upper/ lower cursor keys.
2. Press the right cursor key to enter the menu.
3. Follow the instructions given in the menu.
4. Use the Exit softbutton to leave the menu.

5.6.3 DEMO FUNCTION

see 5.2 (-> page 17)

6 FUNCTIONS MENU



NOTE

All the edited settings are reset to factory settings when the digital piano is switched off and back on again. You can change this behaviour to save various settings (see 6.2.7) In the Functions Menu you can edit numerous settings.

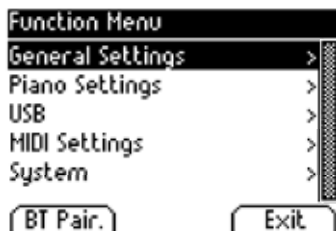

To activate the Functions Menu:

1. Press the Menu softbutton. You have now entered the Functions Menu.
2. Use the upper/lower cursor keys to select one of the available submenus.
3. Press the right cursor key to enter the respective submenu. With the right/left cursor keys you can set values as desired. All changes are adopted immediately.



NOTE

When you enter one of the submenus, the left softbutton is mostly dedicated to the „Reset“ function. Press this softbutton to reset the currently chosen setting to factory default.

4. Use the Exit softbutton to leave the menu.

6.1 TABLE OF SETTINGS

	Main Menu	Sub Menu	Values/Information
General Settings	Brilliance		Mellow2 / Mellow1 / Flat (Standard) / Bright 1 / Bright2 / Boost
	Key Transpose		-12 bis +12
	Tuning		427,0 Hz - 453,0 Hz
	Max Phones Vol.		5 - 20
	Input Volume		0 - 20
	Input->Reverb		0 - 20
	Start-up Settings		Factory / User / Last
	Piano Information		provides information about the model, serial number, software versions of the digital piano
Piano Settings	Keyboard Response	Touch Curve	Constant / Soft2 / Soft1 / Medium (Standard) / Hard1 / Hard2
		Minimum Touch	1 - 20
		Constant Velocity	0 - 127
	Damper Pedal	Half-Pedal Point	0 - 20
		Damper Resonance	0 - 20
	Una Corda Level		-20 bis -2
	Sympathetic Resonance		0 - 20
	Temperament		Equal / Pythagorean / Pure Major / Pure Minor / Mean Tone / Werckmeister / Kirnberger
	Root Note		C - B
	User Key Calibration		keyboard recalibration
	USB Player		-according to file-
USB	Load Song		-according to file-
	Load Lesson Book		-according to file-
	Load Registration		-according to file-
	Save Song	USB Destination	-according to file-
		Int Song	-according to file-
	Save Registration	USB Destination	-according to file-
	Delete File		-according to file-
	Transmit Channel		1 - 16
Midi Settings	Local Control		On/Off
	Program Change		On/Off
	Piano Mode		On/Off
	Display Settings	Backlight	0 - 20
System		Contrast	0 - 20
		Invert	On/Off
	Auto Power Off		Off / 15 / 30 / 60 / 90 / 120 min
	Registrations Restore		!WARNING!
Default Restore		!WARNING!	

	Main Menu	Sub Menu	Values/Information
Bluetooth (NEU)	Bt.Audio Vol		0 - 20
	Bluetooth		On/Off
	Bluetooth Audio		On/Off (indicator)
	Bluetooth MIDI.		On/Off (indicator)
System			
Language			English, German, Dutch, French, Italian, Spanish

6.2 GENERAL SETTINGS

This menu contains general settings.

To access the General Settings Menu, proceed as follows:

1. Enter the Functions Menu by pressing the Menu softbutton.
2. Use the upper/lower cursor keys to select the submenu „General Settings“ and press the right cursor key to enter.
3. Use the Exit softbutton to leave the menu.

6.2.1 BRILLIANCE

The brilliance settings can be used to achieve an even brighter or more mellow sound.

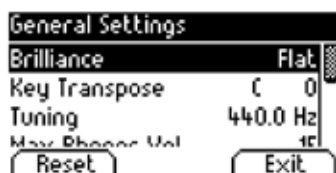

In order to do so, proceed as follows:

1. Enter the “General Settings“ Menu (-> page 28) and navigate to the submenu “Brilliance“.
2. Use the right/left cursor keys to set the desired brilliance.
3. Use the Exit softbutton to leave the menu.

6.2.2 KEY TRANSPOSE

If you need to adjust to the key another musician is playing in, you can simply achieve this by transposing your digital piano.

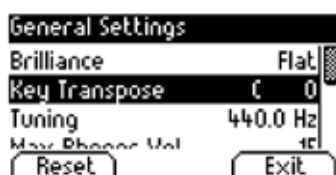

In order to do so, proceed as follows:

1. Enter the “General Settings“ Menu (-> page 28) and navigate to the submenu “Key Transpose“.
2. Use the right/left cursor keys to transpose as far as desired while checking on the keyboard.
3. Use the Exit softbutton to leave the menu.



TIP

You can see at first glance in the main menu whether a transpose is activated. In this case the abbreviation „Tr“ at the upper right corner is highlighted in black.

6.2.3 TUNING

If you need to fine-tune the sounds of your digital piano, you can use this function.

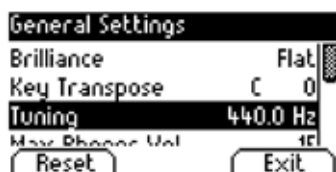

In order to do so, proceed as follows:

1. Enter the "General Settings" Menu (-> page 28) and navigate to the submenu "Tuning".
2. Use the right/left cursor keys to set the desired pitch.
3. Use the Exit softbutton to leave the menu.

6.2.4 MAX PHONES LEVEL

With this function, you can determine the maximal headphones volume in the ratio to your piano when the volume switch is at its loudest setting.

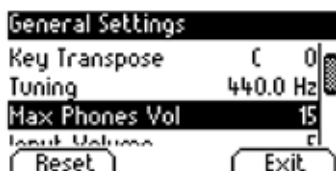

In order to do so, proceed as follows:

1. Enter the "General Settings" Menu (-> page 28) and navigate to the submenu "Max Phones Vol.".
2. Use the right/left cursor keys to set the desired volume.
3. Use the Exit softbutton to leave the menu.

6.2.5 INPUT VOLUME

This function determines the volume of an audio device connected via the LINE IN port in the ratio to the overall volume of the piano.

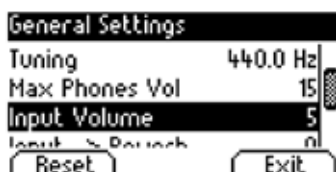

In order to do so, proceed as follows:

1. Enter the "General Settings" Menu (-> page 28) and navigate to the submenu "Input Volume".
2. Use the right/left cursor keys to set the desired volume.
3. Use the Exit softbutton to leave the menu.

6.2.6 INPUT REVERB / REVERB VOLUME

With this function you can determine the volume of the reverb in comparison to the played sound.



In order to do so, proceed as follows:

1. Enter the "General Settings" Menu (-> page 28) and navigate to the submenu "Input -> Reverb".
2. Use the right/left cursor keys to set the desired volume.
3. Use the Exit softbutton to leave the menu.

6.2.7 START-UP SETTINGS

With this function you can determine which settings should be loaded when switching on the digital piano.

In order to do so, proceed as follows:

1. Enter the "General Settings" Menu (-> page 28) and navigate to the submenu "Start-up Settings".

2. Use the right/left cursor keys to select one of the following settings:

- **Factory:** The piano starts with the factory default.
- **User:** In case you have saved a fixed "Default" setting (-> page 38), this will be loaded when the piano is turned on.
- **Last:** When being started, the piano maintains the settings which were selected before switching it off..

3. Use the Exit softbutton to leave the menu.

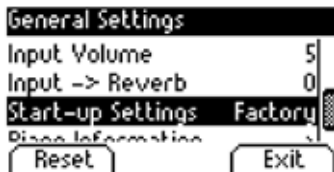

6.2.8 PIANO INFORMATION

This function provides information concerning the hardware and software version of your GEWA digital piano. You need this information for callbacks with the service team.

Proceed as follows to access the relevant information:

1. Enter the "General Settings" Menu (-> page 28) and navigate to the submenu "Piano Information".

2. Press the right cursor key. The required information is displayed now.

3. Use the Exit softbutton to leave the menu.

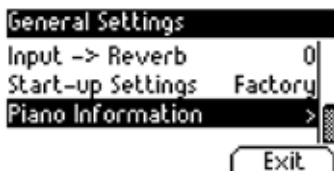

6.3 PIANO SETTINGS

This section deals with customizing your GEWA digital piano to your personal preferences. It includes keyboard, pedal and resonance behaviour.

To access the Piano Settings Menu, proceed as follows:

1. Enter the Functions Menu by pressing the Menu softbutton.
2. Use the upper/lower cursor keys to select the submenu "Piano Settings" and press the right cursor key to enter.
3. Use the Exit softbutton to leave the menu.

6.3.1 KEYBOARD RESPONSE / TOUCH SENSITIVITY

With this function you can change the touch sensitivity of the keyboard. The more sensitive you set it, the less force you will need to press the keys to produce a louder sound.

To change the touch sensitivity, proceed as follows:

1. Enter the "Piano Settings" Menu (-> see 6.3) and navigate to the submenu "Keyboard Response" by using the upper/lower cursor keys.
2. Enter the submenu by pressing the right cursor key. The following settings are adjustable now:

- **Touch Curve:** Choose one of the preset levels of sensitivity:
 - Medium: Default setting. It corresponds to a medium sensitivity and is recommended for most players.
 - Soft 1: High touch sensitivity. This is recommended for in experienced players and children.
 - Soft 2: Very high touch sensitivity.
 - Hard 1: Low touch sensitivity. This one is suitable for players with a high strike force.
 - Hard 2: Very low touch sensitivity.
 - Constant: Without any touch sensitivity.



Check how the different sensitivity levels feel by playing on the keyboard to find out your personal preference.

- **Minimum Touch:** Here you can define the minimum touch.
 - **Constant Velocity:** Set a value for the touch sensitivity of the Constant touch curve here.
3. Use the Exit softbutton to leave the menu.

6.3.2 DAMPER PEDAL

With this function you can change the behaviour of the damper (or sustain) pedal of your digital piano. When it comes to acoustic pianos, the damper pedal cannot only be switched on and off but can be played in a nuanced manner (“half-pedaling”). Furthermore, the strings resonate when the pedal is depressed (“damper resonance”). These two features are simulated by your digital piano which contributes to a highly natural sound result.

To adjust the damper pedal settings, proceed as follows:

1. Enter the “Piano Settings“ Menu (-> see page 31) and navigate to the submenu “Damper Pedal“ by using the upper/lower cursor keys.
2. Enter the submenu by pressing the right cursor key. The following settings are adjustable now:
 - **Half-Pedal Point:** Here you can define the point at which half-pedaling should be activated when the damper pedal is depressed.
 - **Damper Resonance:** Determine, how intensively the resonance noise should be added when depressing the damper pedal.
3. Use the Exit softbutton to leave the menu.

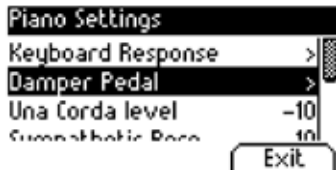

6.3.3 UNA CORDA LEVEL

With this function you can determine how heavy the left pedal (“Una Corda level“) of your digital piano should have an impact on the sound.

To adjust the Una Corda level, proceed as follows:

1. Enter the “Piano Settings“ Menu (-> see page 31) and navigate to the submenu “Una Corda level“ by using the upper/lower cursor keys.
2. With the right/left cursor keys, adjust the setting as desired.
3. Use the Exit softbutton to leave the menu.



6.3.4 SYMPATHETIC RESONANCE

When pressing a key on an acoustic piano, some strings start resonating indirectly. This behaviour is simulated by your GEWA digital piano which contributes to a significantly natural sound. You can define the intensity of this feature here.

To adjust the string resonance, proceed as follows:

1. Enter the “Piano Settings“ Menu (-> see page 31) and navigate to the submenu “Sympathetic Resonance“ by using the upper/lower cursor keys.
2. With the right/left cursor keys, adjust the setting as desired. Check the result by playing on the keyboard.
3. Use the Exit softbutton to leave the menu.



6.3.5 TEMPERAMENT

You can adjust the tuning, also called 'temperament', of your digital piano e.g. to play music from older epochs with the utmost authenticity. This is especially useful for the harpsichord sound of your GEWA digital piano.

To adjust the temperament, proceed as follows:



1. Enter the "Piano Settings" Menu (-> see page 31) and navigate to the submenu "Temperament" by using the upper/lower cursor keys.

2. With the right/left cursor keys, choose one of the following tunings/temperaments:

- Equal Equal temperament (Standard tuning for modern pianos).
- Pythagorean Tuning system based on pure 5ths, suitable for medieval music.
- Pure Major Pure tuning for modal music like Indian classical music.
- Pure Minor Pure tuning for modal music in minor.
- Meantone Based on pure 3rds, suitable for Renaissance and Baroque music.
- Werck. III Well-tempered tuning system which inspired J.S. Bach's Well Tempered Clavier.
- Kirnb. III A different well-tempered tuning widely used in Baroque organs.

3. Use the Exit softbutton to leave the menu.

6.3.6 ROOT NOTE

Within this submenu you can define the root note of a temperament (see 6.3.5). If you choose When pressing a key on an acoustic piano, some strings start resonating indirectly. This behaviour is simulated by your GEWA digital piano which contributes to a significantly natural sound. You can define the intensity of this feature here.



To choose the adequate root note, proceed as follows:

1. Enter the "Piano Settings" Menu (-> see page 31) and navigate to the submenu "Root Note" by using the upper/lower cursor keys.

2. With the right/left cursor keys, select the desired root note.

3. Use the Exit softbutton to leave the menu.

6.4

USB

Within this menu, you control all settings and functions related to the USB connection of your digital piano.

To access the USB menu, proceed as follows:

1. Plug a USB device into the respective USB port. The note „Drive found“ briefly indicates that the connection has been successful. In the main screen, the abbreviation „Drv“ is highlighted in black.
2. Enter the Functions Menu by pressing the Menu softbutton and use the upper/lower cursor keys to select the submenu „USB“. Then press the right cursor key to enter.
3. Navigate through the following submenus which open up when the right cursor key is pressed:



- **USB Player:** This function grants access to the USB Player (-> page 25)
- **Load Song:** A song stored to the USB device can be uploaded on the digital piano.
- **Load Lesson Book:** Songs in a special eLearning format can be loaded from the USB device to the digital piano.
- **Load Registrations:** Here you can load a registration which has been saved on the USB device.
- **Save Song:** You can save a recording to the USB stick here. Select the desired song by using the cursor keys and press the “Save” softbutton to store it to USB.
- **Save Registrations:** With this function, you are able to save an individual registration to USB. Select the desired registration by using the cursor keys and press the “Save” softbutton.
- **Delete File:** You can delete a file from your USB stick here. Choose the file you intend to delete by using the upper/lower cursor keys and press the “Delete” softbutton.

4. Follow the instructions of the respective menu by making use of the cursor keys and the softbuttons.
5. Use the Exit softbutton to leave the menu.
6. Disconnect the USB device. “Drive lost“ is briefly displayed.

6.5

SYSTEM

Here you can determine settings affecting the system as a whole.

To access the System menu, proceed as follows:

1. Enter the Functions Menu by pressing the Menu softbutton.
2. Use the upper/lower cursor keys to select the submenu „System“ and press the right cursor key to enter.
3. Use the Exit softbutton to leave the menu.

6.5.1 DISPLAY SETTINGS

You can adjust the display here.

Proceed as follows:

1. Enter the "System" Menu (-> see 6.5) and navigate to the submenu "Display Settings" by using the upper/lower cursor keys.
2. Enter the submenu by pressing the right cursor key. Navigate through the following settings by using the upper/lower cursor keys:

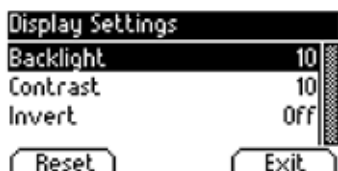

- **Backlight:** You can determine the intensity of the backlight here..
- **Contrast:** Here you can define the display contrast between black and white.
- **Invert:** Black and white are inverted with this function.

3. Use the right/left cursor keys to adjust the display.
4. Use the Exit softbutton to leave the menu.

6.5.2 AUTO POWER OFF

In order to save energy, your digital piano possesses an Auto Power Off function. After the selected amount of time in which you do not play a key or press a button, the piano turns off automatically.

To adjust the time frame, proceed as follows:

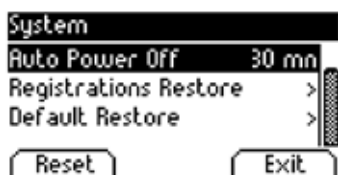

1. Enter the "System" Menu (-> see 6.5) and navigate to the submenu "Auto Power Off" by using the upper/lower cursor keys.
2. Use the right/left cursor keys to adjust the period of time as desired.
3. Use the Exit softbutton to leave the menu.

6.5.3 REGISTRATIONS RESTORE

WARNING! With this function, you delete all registrations which are saved to the „User Settings“ function (-> page 38).

Proceed as follows:



1. Enter the "System" Menu (-> see 6.5) and navigate to the submenu "Registrations Restore" by using the upper/lower cursor keys.
2. Press the right cursor key. Then follow the instructions given within the menu.
3. Use the Exit softbutton to leave the menu.

6.5.4 DEFAULT RESTORE

WARNING! With this function, you delete your individual standard settings which has been stored to the "Default" function of the "User Settings" (-> page 38).

Proceed as follows:



1. Enter the "System" Menu (-> see 6.5) and navigate to the submenu "Default Restore" by using the upper/lower cursor keys.
2. Press the right cursor key. Then follow the instructions given within the menu.
3. Use the Exit softbutton to leave the menu.

6.6 MIDI SETTINGS

Here you can adjust the MIDI functions of your digital piano.

To access the System menu, proceed as follows:

1. Enter the Functions Menu by pressing the Menu softbutton.
2. Use the upper/lower cursor keys to select the submenu „MIDI Settings“ and press the right cursor key to enter.
3. Use the Exit softbutton to leave the menu.

6.6.1 TRANSMIT CHANNEL

Use the MIDI transmission channel to specify which channel (1-16) should transmit signals between the digital piano and the connected device.

To select the MIDI transmit channel, proceed as follows:



1. Enter the “MIDI Settings“ Menu (-> see 6.6) and navigate to the submenu “Transmit Channel“ by using the upper/lower cursor keys.
2. Use the right/left cursor keys to select a transmit channel. The determined channel defines:
 - In Split Mode: the transmit channel of the right keyboard zone. The left keyboard zone is automatically transmitted through the next highest MIDI channel.
 - In Dual Mode: the transmit channel of the first sound. The second sound is automatically transmitted via the next highest MIDI channel.
3. Use the Exit softbutton to leave the menu.

6.6.2 LOCAL CONTROL

The Local Control function enables you to mute the built-in speakers of your digital piano while signals are still transferred via the MIDI OUT connection (Off). This is very useful if you would like to operate a different instrument or a computer-based recording program using the keyboard of your digital piano, without producing sound from the digital piano at the same time. If you want to reenabte the internal sound, set this value to “On“.



Proceed as follows:

1. Enter the “MIDI Settings“ Menu (-> see 6.6) and navigate to the submenu “Local Control“ by using the upper/lower cursor keys.
2. Use the right/left cursor keys to set the parameter to On/Off.
3. Use the Exit soft button to leave the menu.

6.6.3 PROGRAM CHANGE

With the Program Change function you can determine whether the information about a program change (the selection of another sound) should be transmitted to the MIDI device connected to the MIDI OUT terminal or received from a connected MIDI device (On). If you do not want this information to be transferred, set this parameter to Off.



Proceed as follows:

1. Enter the "MIDI Settings" Menu (-> see page 36) and navigate to the submenu "Program Change" by using the upper/lower cursor keys.
2. Use the right/left cursor keys to set the parameter to On/Off.
3. Use the Exit softbutton to leave the menu.

6.6.4 PIANO MODE

With the Piano Mode function you determine how incoming MIDI data of channels 1 and 2 are processed. If the mode is disabled (Off), only the GM-Chorus is available for all 16 MIDI transmit channels.

If the Piano-Mode is enabled (On) and if a piano sound is selected, channels 1 and 2 are enriched with compatible piano effects (string resonance, damper resonance). For the channels 3 to 16, the GM Chorus still can be added.

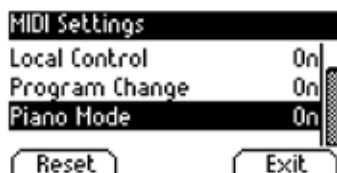

Proceed as follows:

1. Enter the "MIDI Settings" Menu (-> see page 36) and navigate to the submenu "Piano Mode" by using the upper/lower cursor keys.
2. Use the right/left cursor keys to set the parameter to On/Off.
3. Use the Exit softbutton to leave the menu.



NOTE

By default, the Piano Mode is set to "On".

6.7 BLUETOOTH SETTINGS

The Bluetooth Settings menu allows you to make settings for your digital piano's Bluetooth interface.



This is how you can access it:

1. Activate the FUNCTION menu by pressing the MENU soft button
2. Use the cursor UP/DOWN keys to select the „Bluetooth“
3. Press the EXIT soft button to leave the menu again

6.7.1 BT. AUDTIO VOL



This settings allows you to define the input volume of the audio signal via the Bluetooth interface. Use the cursor LEFT/RIGHT keys to set the corresponding value. Values between 0 - 20 are possible.

6.7.2 BLUETOOTH



Here you can switch the Bluetooth module on or off using the cursor buttons LEFT/RIGHT

6.7.3 BLUETOOTH AUDIO

Shows whether there is an active Bluetooth audio connection on the digital piano.

6.7.4 BLUETOOTH MIDI

Indicates whether there is an active Bluetooth MIDI connection.

7 USER SETTINGS

7.1 REGISTRATION OF SETTINGS

Your digital piano can store settings to up to 3 banks (A, B, C) which contain 6 slots each. This enables you to keep your favourite user settings readily available on demand. You can register all sounds with assigned effects, sound combinations (Split, Dual, 4Hand), metronome settings as well as almost every setting within the Function Menu.

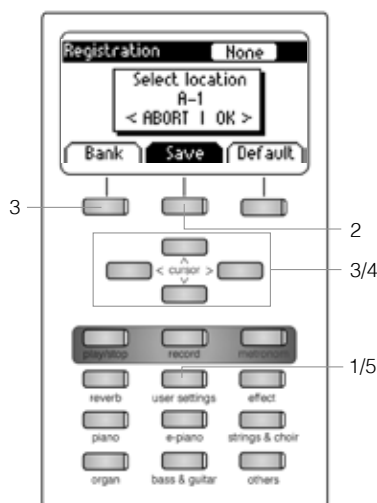

To register a setting, proceed as follows:

1. Press the "User Settings" button.
2. Press the "Save" softbutton.
3. Use the "Bank" softbutton to select one of the banks and the upper/lower cursor keys to select the final storage space.
4. Press the right cursor key (OK) to register your setting or the left cursor key (Abort) to cancel.
5. Use the "User Settings" button again to leave the registration mode.



NOTE

You can overwrite your registrations as often as desired.



TIP

If you have found the ideal setting that satisfies all of your personal preferences, you can define it as "Default" so that it is loaded immediately when switching on the digital piano. In order to do so, proceed as described above in steps 1 and 2. Save the setting as "Default" by pressing the respective softbutton and confirm your choice with the right cursor key (OK). Then, select "User" as the desired start-up setting (-> page 30).

7.2 APPLYING REGISTRATIONS

In order to use one of your saved user settings registrations, proceed as follows:

1. Press the "User Settings" button.
2. Press the "Bank" softbutton to select the desired Bank (A, B, C).
3. The 6 sound selection switches represent the 6 slots of each bank now (Bank A: Piano = A1, EPiano = A2, ...). Press a sound selection switch to gain access to the desired storage space. If you want to choose the Default Setting, press the Default softbutton instead.
4. Use the "User Settings" button again to leave the registration mode. The setting remains.



NOTE

If the pop-up "Empty" is displayed when selecting a specific slot, you have not saved any registration to it yet.

8 RECORDING AND PLAYBACK

Your digital piano has various functions for recording your playing. In the recorder menu you can choose whether you want to use the internal recording option or the USB-WAV recorder

8.1 INTERNAL RECORDING OPTIONS

To record an own song, proceed as follows:

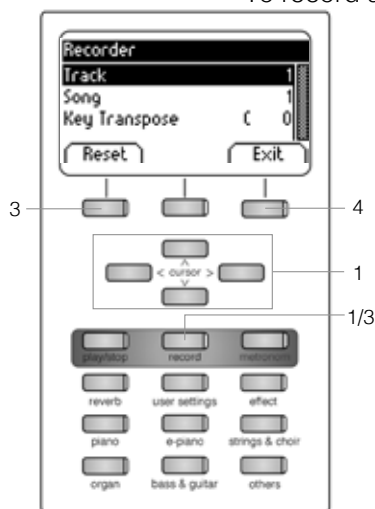

1. Enter the Recorder menu by pressing the Record button. With the cursor keys, you can adjust the following:

- **Track:** Decide if you want to record track 1 or 2.
- **Song:** Choose one out of 4 recording memory spaces.
- **Key Transpose:** Transpose your piano here (-> page 28).

2. Now start playing. The recording begins when pressing the first key.

3. Press the Record button again to stop recording. Overwrite the current recording as often as desired.

4. Use the Exit softbutton to leave the menu.



NOTE

Recordings are saved permanently. They are not deleted automatically when switching off the digital piano.

8.1.1 RECORDING WITH METRONOME SUPPORT

You can enable the metronome which supports you while recording.

Proceed as follows:

1. Adjust the metronome as desired (-> page 24).
2. Enter the Recorder menu by pressing the record button and adjust everything as preferable (-> see 8.1).
3. Press the Metronome button. The metronome is activated now.
4. Depending on which beat you have chosen, you have the following results:
 - Classic metronome: This only serves as an orientation and will therefore not be audible in the recording.
 - Accompanying drum beat: This will be recorded. After pressing the metronome button, the piano plays back a two bar count-in before it automatically starts recording. This will make it easier for you to begin playing in time.
5. Press the Record button as usual to stop recording.

8.2 USB - WAV RECORDER

To record a song as an audio file to you USB stick, please proceed as follow::

1. Press the record button. In the recorder menu, press F2 butto to enter the USB recording mode.
2. In this menu you have the following options:

```

USB Recorder
Dest. Name  GwHav_1.wav
Overdub     None
  
```

Menu Exit

```

USB Recorder
Dest. Name  GwHav_1.wav
Overdub     None
  
```

Menu Exit

```

USB Recorder
Dest. Name  GwHav_1.wav
Overdub     Int. Song
  
```

```

INT. SONG 1
Select Exit
  
```

- DEST.NAME is the file name which will be saved onto the USB stick. If you change the file name , a new fill be created automatically. If a recording with the same name already exists, it will be overwritten automatically.

- To change the DEST.NAME, press F1 - Renman. Use the LEFT and RIGHT cursor buttons to select the letter to be changed, and the UP and Down keys to change the corresponding letter.

- To apply the changes, press F1 - Rename again.

- OVERDUB: With the Overdub funktion you can select if you want to add your playing to an already existing recording. Overdub is disabled and set to "Non" by default. To activate the function, use the LEFT and RIGHT cursor buttons.

- Overdub – Int. Song: Overdub – Int. Song allows you to select a song that you have already recorded via the internal recorder (see p. XX). Press F1 – Select to select the corresponding song.

- Overdub – USB Song: With Overdub – USB Sond you can select a ong from your USB device. To do so, press F1 – Select and select the corresponding song.

3. To fast-forward (FFW) or rewind (REW) the recording, use the right/left cursor keys. Pressing briefly lets you skip bars as a whole, while holding them down speeds the recording up.
4. Press the Play / Stop button as usual to stop the playback.



TIP

While playing back a song, you can accompany your recording by playing on the keyboard. In this way, you can play “four-handed“ with a second virtual pianist.



NOTE

To play back another song, press the Menu Softbutton. Navigate to the menu item “Song“ and select the desired one.

8.3 EDITING RECORDINGS

After recording, you can make further adjustments to your songs.

Proceed as follows:



1. Press the Play / Stop button to open the Song Player.
2. Press the Menu softbutton. The Song Player opens up. Adjust the following settings with the cursor keys:

- **Track Mute:** Mute one of the two tracks here.
- **Song:** Choose the song you want to adjust here.
- **Delete Song:** Delete songs with this function.
- **Key Transpose:** Transpose your piano here (-> page 28)..
- **Song Transpose:** Transpose your recording here.
- **AB Countin Bars:** Select the amount of counting bars for the loop function here (-> see 8.4)

3. Press the Exit softbutton to leave the menu.
4. Press the Exit softbutton again to return to the main screen.

8.4 LOOP

You can play back a specific part of a recorded song in loop (over and over again) for practice purposes.

Proceed as follows:

1. Enter the Song Player, choose the song you want to practice and start the playback (-> see 8.2).
2. Press the Set A softbutton to determine the starting point of the loop.
3. Press the Set B softbutton to determine the ending point of the loop. Now the metronome counts one bar and starts playing the loop of the selected part.
4. If you want to adjust the amount of counting bars, press the Menu softbutton in the Song Player and select the preferable amount.
5. Use the Clear AB softbutton to end the loop.

9 KEYBOARD USER CALIBRATION

Each GEWA digital piano is calibrated during the manufacturing process. That means that the dynamic behaviour of each keyboard is measured in a special procedure; it is then tuned precisely in order to achieve uniformity between the volume of the individual tones, and this tuning is stored to each digital piano.

As with an acoustic piano or grand piano, it can also happen with a digital piano that the complex mechanism deviates slightly from its original adjustment during transportation or heavy use over a long period of time, causing slight irregularities to occur. With an acoustic upright or grand piano, a piano-tuner or technician would regularly balance the mechanics to restore its uniform playability.

Your GEWA digital piano is much less sensitive to transport or stress. However, if it happens that one or more keys seem to play too loudly or too quietly, you can easily adjust this in the software of the piano itself. To do so, we offer the calibration mode for all our models. Although the process is very easy, we recommend only experienced users to carry out a calibration themselves, and in case of doubt, to consult a piano technician or GEWA retailer.

9.1 ENTERING THE CALIBRATION MODE

To enter the calibration mode, proceed as follows:

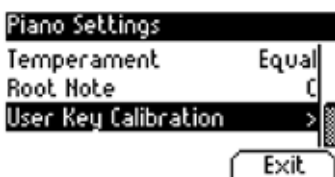

1. Press the Menu softbutton to enter the Functions Menu.
2. Select the entry "Piano Settings" with the upper/lower cursor keys and enter this menu with the right cursor key.
3. Navigate through the menu with the upper/lower cursor keys and use the right cursor key to select the entry User Key Calibration.

9.2 CREATING A USER CALIBRATION

If you have never used the Calibration Mode before, the piano usually starts with the so called **Factory Calibration**. When you change the calibration of your digital piano, the data is stored to the so called **User Calibration** and henceforth the piano will start with that one. You can change the User Calibration or restore the Factory Calibration at any time.

To perform the calibration, do the following:



1. While the first entry "Key" is highlighted, you can select the key you want to calibrate by simply playing it on the keyboard. The piano will recognize which key you played and will display its name. Alternatively you can use the left and right cursor keys to navigate from one key to the other.
2. Select the entry "Corr." (= correction) with the lower cursor key and set the calibration value with the left and right cursor keys. To the left side the key becomes "softer" and to the right side it becomes "harder". The bar in the middle of the display graphically shows the deviation from zero. At the right, the numerical value is displayed.
3. Repeat the process for each key you intend to calibrate.



While "Corr." is selected, repeatedly play the adjacent keys with the same intensity to hear whether the tone being calibrated fits in evenly. Before calibrating up and down, make sure that the desired key is shown in the display.

9.3 COMPARING FACTORY AND USER CALIBRATION

In order to check whether the user calibration has been successful, it is recommended to compare it to the original factory calibration by using the Factory softbutton (1) and the User softbutton (2).

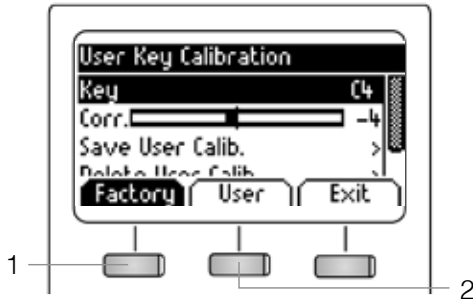

The recently selected calibration type is highlighted in the display. While the user calibration can be adjusted at any time, the factory calibration is invariable.

9.4 SAVING AND DELETING THE USER CALIBRATION

To save the created user calibration or any later adjustments, select the entry „Save User Calib.“ by using the upper/lower cursor keys and confirm using the right cursor key. To delete the created user calibration, select the menu item „Delete User Calib.“ by using the upper/lower cursor keys and confirm your choice using the right cursor key. If you do not save the user calibration, it is only applied until you turn your digital piano off.

9.5 EXITING THE CALIBRATION MODE

To exit the calibration mode, press the Exit softbutton.



NOTE

Before exiting the calibration mode, make sure the calibration you want to use is selected. If necessary, use the Factory and User softbuttons.

You will find all information on updates at our website:
www.gewakeys.com

10

CONNECTING EXTERNAL DEVICES

Here you can learn how to connect external devices to your digital piano.

10.1 CONNECTING HEADPHONES

Connect one or two headphones to the two 6.3 mm jack connectors under the console.



NOTE

If headphones are connected to either one of the headphone output connectors, the speakers of your GEWA digital piano are automatically deactivated and will only be reactivated after you have removed the headphone/s. Make sure both connectors are unplugged.

10.2 CONNECTING A PLAYBACK DEVICE

You can connect playback devices such as e.g. a CD or MP3 player to your digital piano. This can be helpful when you are rehearsing a song in Playback mode. When properly connected you will be able to hear both, the piano and the Playback device either through the piano speakers or connected headphones. You can control the volume balance easily with the volume control.

10.3 CONNECTING AN AMPLIFIER

If you need your digital piano to play louder than with the built in speakers, you can easily connect it to an amplification system using the LINE OUT outputs under the console.

10.4 CONNECTING A PC

You can link your digital piano with your PC with the USB-B connection under the console.

This is how you can link your PC with your digital piano:

1. Switch off your digital piano and the PC.
2. Connect your digital piano with your PC with a certified USB lead.
3. Switch on your digital piano and the PC.

Your digital piano will be automatically recognized by your PC. There are various appropriate software tools (e.g. recording software) on most available operating system platforms and devices with which you can enjoyably extend your musical experience.



NOTE

To check the details on the data exchange between your digital piano and the PC, it is recommended that you use the PC software provided monitoring tools.

10.5 BLUETOOTH AUDIO

You can connect an external Bluetooth device (smartphone, tablet, ...) to your GEWA digital piano.

To connect your digital piano via Bluetooth, proceed as follows:



1. Press the Menu softbutton in the home screen. The upper left softbutton is now defined as "BT-Pair".
2. Press the BT-Pair softbutton and search for the piano on your smartphone or tablet.
3. The digital piano requires a PIN code now.
It is **4392 (GEWA)**.
4. After the connection has been successfully made, you can play back audio files through the speakers as desired.
5. You can also change the input volume (-> page 29).

11

USEFUL INFORMATION

At this point, we would like to provide definitions for a few terms that are used in this manual.

We also explain the special features of your digital piano here.

11.1

INDEX

MIDI	<p>Musical Instrument Digital Interface is a data transmission protocol. That means that musical control information is transmitted between electronic instruments such as digital pianos, keyboards, synthesizers, drum computers and also PCs and laptops. To exchange this control information, the instruments/computer need MIDI connectors and a connection must be made between them. There are different MIDI connections with different functions: MIDI-IN, MIDI-OUT and MIDI-THRU. The latter forwards the data received via the MIDI input unaffected to another MIDI device.</p> <p>Example: When you press a key on the digital piano, small data packages are sent via its MIDI OUT port. These data packages contain information concerning the pitch and velocity of the corresponding tone. They can, for example, be recorded, stored and played back on the computer. Moreover, they can be transformed into musical notation on screen if there is an appropriate program.</p>
GM	<p>General-MIDI (abbrev. GM) standardises significantly more than the universal MIDI standard. The latter is both a hardware and protocol specification. General-MIDI also specifies content. GM sets a minimum standard for the allocation of instruments on the 128 program slots. According to GM, a compatible tone generator must be able to produce 24 sounds at a time. According to GM, further control parameters are defined e.g. the effect control.</p>
General MIDI Sounds	<p>Sounds or instruments according to the specifications of the general MIDI standard.</p>
Reverb	<p>The device simulates how the sound in a room would be. This sound simulation is already preconfigured for some sounds to make them more realistic.</p>
Chorus	<p>The Chorus Effect adds a copy of the played notes which is slightly detuned. Therefore the sound seems fuller.</p>
Samples	<p>Samples are sound recordings of instruments. The notes of the instruments are recorded and stored individually. When you play a note on the keyboard of the digital piano, the corresponding recordings are played back.</p>
Polyphony	<p>With electronic instruments, the term 'polyphony' refers to how many tones can be played at the same time.</p>

11.2

WARRANTY

The dealer from whom the device was purchased warrants the material and manufacture of the device for a period of 2 years from the date of purchase. In the case of a defect product, the buyer is initially only entitled to a subsequent performance. This includes either the repair or the delivery of a replacement product. Replaced equipment or parts become the property of the dealer.

If the subsequent performance fails, the buyer can either demand a reduction in the purchase price or withdraw from the contract and, if the defect is to be represented by the dealer, claim for damages or reimbursement of wasted expenditure.

The buyer must notify defects to the dealer without delay. Proof of warranty is to be provided by a proper confirmation of purchase (proof of purchase e.g. invoice)

Damage caused by force or other external influences are not covered by the warranty, nor are the consumption of consumer goods such as rechargeable batteries, strings, skins or seals. If you suspect a warranty claim with your device, contact your dealer during normal business hours.

12

TROUBLESHOOTING AND REPAIR

If malfunctions occur, you can use the tips listed here to find and solve the issue yourself. If you are unsuccessful, please contact your dealer.

Possible cause and solution		
Problem	Possible cause(s)	Possible solution(s)
The piano does not switch on	<ul style="list-style-type: none"> • Power plug is not plugged in. • Power cable is not connected properly. 	<ul style="list-style-type: none"> • Check the power cable and its connections. • Reconnect it if necessary.
Crackling/pop noise when switching on/off.	<ul style="list-style-type: none"> • This is normal and may occur when the digital piano is turned on and off. 	
Noise occurs through speakers during operation.	<ul style="list-style-type: none"> • Interference with other devices (e.g. mobile phones). 	<ul style="list-style-type: none"> • Increase the distance between the digital piano and other devices or turn off the other devices.
The sound is too low or is not audible at all.	<ul style="list-style-type: none"> • The volume control is set too quietly. • Headphones are connected. 	<ul style="list-style-type: none"> • Make the volume control go louder. • Remove them.
The pedals are not working properly.	<ul style="list-style-type: none"> • The pedal cable is not properly connected. 	<ul style="list-style-type: none"> • Check that the pedal cable is properly in the socket. • Reconnect if necessary.

13

TECHNICAL DATA

Name	Feature
Dimensions WxDxH (with set up music desk) in cm	143.4 x 42.0 x 86.5 (102.5) cm
Weight	55 kg
Power input	max 75 Watt
Keyboard	88 keys, Concert Pianist II, Graded Hammer, Wooden Elements, Ivory Touch
Touch sensitivity	6 levels (Soft1, Soft2, Medium, Hard1, Hard2 and Constant)
Pedals	Damper-, Sostenuto- and Piano Pedal
Sound source	GEWA music samples with 4 stereo layers
Polyphony	256
No. of integrated sample sounds	40
Amplifier output RMS	2 x 20 Watt
Speakers	2 x fullrange speakers
Recording	Integrated 2-Track Recorder
Recording format	Standard MIDI-file (Format 0, SMF)
Connections	<ul style="list-style-type: none"> - power socket - MIDI In - MIDI Out - LINE In - LINE Out - 2 x headphone (6.3 mm jack) - USB Type A - USB Type B - Sustain Pedal

Manufacturer:
GEWA music GmbH
Werkstraße 1
08626 Adorf
GERMANY
www.gewamusic.com
Version 1.0



Errors and omissions excepted!