

RØDE[®]
MICROPHONES

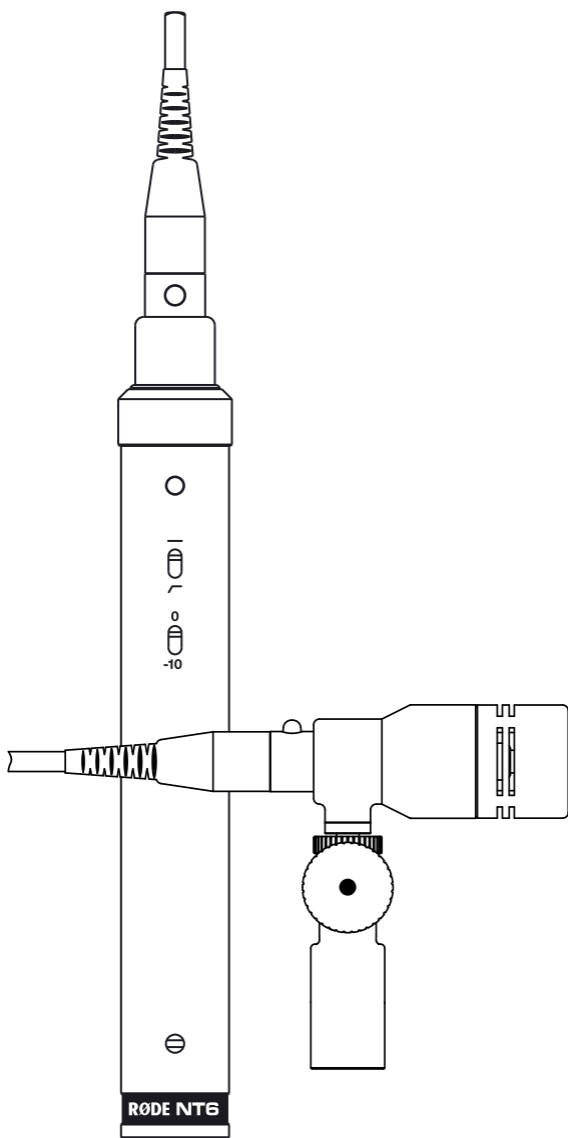

NT6

Instruction Manual



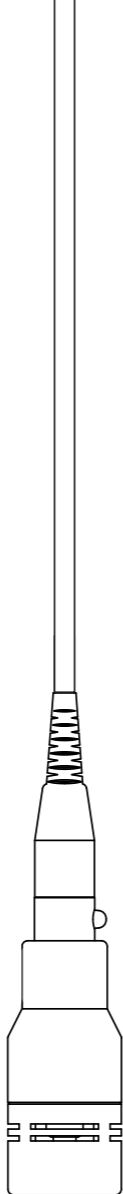

RØDE NT6

I want to thank you for purchasing a **RØDE** NT6.

Please take the time to read this manual as it contains information that will help you achieve the best results from your microphone, as well as help you get many years of reliable service from your investment.

The RØDE NT6 is specifically designed for difficult mounting applications. Although clearly relevant to instrument mic'ing, the NT6 is extremely well suited to situations where a small 'unobtrusive' but powerful microphone system is required.

The NT6 utilises the 1/2" (externally biased) gold sputtered true condenser transducer used in the internationally renowned RØDE NT5. The capsule attaches to a custom made, multi-position swivel mount allowing it to be independently positioned with ease.

The capsule connects to the pre-amplifier (body) by a custom 3 m Kevlar® fibre reinforced cable. Housed within the heavy duty satin-nickel-plated body, is a state-of-the-art low noise balanced output preamplifier, exhibiting a wide dynamic range and full frequency response.

The pre-amplifier circuit incorporates a 2-position variable pad: 0 dB and -10 dB attenuation, and a 2-position variable high-pass filter that enables you to step from flat response to 80 Hz high pass filter.

The NT6 is intended for Film, Television, Broadcast, Live Performance, Theatre, Surround and Environmental recording applications or wherever your imagination takes you.

The NT6 is complemented with a diverse range of accessories to better facilitate positioning and attachment. For more details of these accessories and any additions to the range visit our website: www.rodemic.com

If you have any questions or comments, please don't hesitate to contact us direct at info@rodemic.com



Peter Freedman
Sydney, Australia

RØDE NT6

Specifications

Acoustic Principle:

Externally polarised 1/2" (13 mm) pressure gradient condenser.

Directional Pattern:

Cardioid

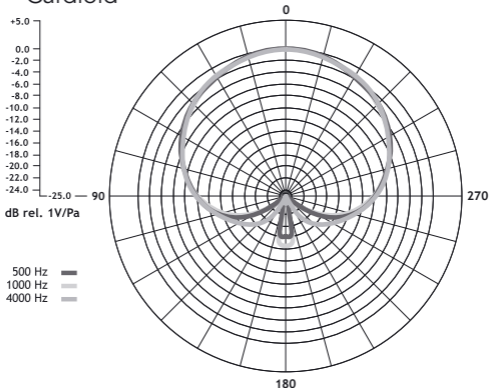

Frequency range:

40 Hz ~ 20 000 Hz selectable HPF
@ 80 Hz/12 dB/octave

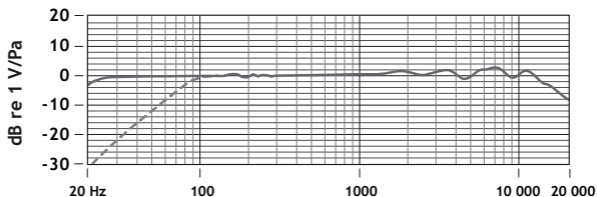

Output Impedance:

200 Ω

Signal/Noise ratio DIN/IEC 651:

75 dB

(1 kHz rel 1 Pa; per IEC651, IEC268-15)

Equivalent Noise:

19 dB SPL (per IEC651, IEC268-15)

Maximum SPL:

138 dB (@ 1% THD into 1 k Ω)

148 dB (@ 1% THD into 1 k Ω) - pad max.

Sensitivity at 1 kHz into 1 k Ω :

-38 dB re 1 Volt/Pascal

(16 mV @ 94 dB SPL) +/- 2 dB

Maximum output voltage:

6 dBu (@ 1% THD into 1 k Ω)

Dynamic Range - DIN/IEC 651:

119 dB (per IEC651, IEC268-15)

Power (Supply voltage):

48 Volts (P48), 24 Volts (P24) phantom

RØDE NT6

Specifications cont.

Output Connection:

3 pin XLR, balanced output between pin 2(+), pin (-) & pin 1 (ground)

Weight:

386 gm. (12.41 oz.)

Dimensions:

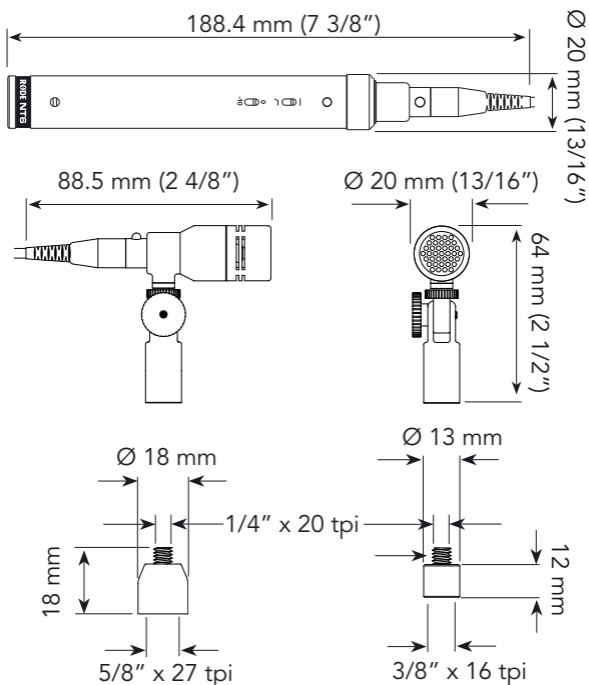

Features

- 1/2" (externally biased) gold sputtered true condenser capsule
- Heavy duty satin-nickel-plated body
- 2-position variable pad: 0 dB and -10 dB
- 2-position variable high-pass filter: flat and 80 Hz
- Low noise Surface mount technology
- Wide dynamic range
- Full frequency response
- Supplied complete with 2-axis swivel mount, 3 m Kevlar® fibre reinforced cable, RM5 clip, WS5 (Black) Wind Shield and Soft Pouch
- Designed & manufactured in Australia
- Full 10 year guarantee

RØDE NT6

Powering your NT6

The NT6 is designed to operate from phantom power to the P48 standard, between 44 V and 52 V applied with positive polarity to pin 2 and pin 3 of the output XLR connector.

The NT6 will operate satisfactorily into a load impedance as low as 1 k Ω . If a load below this is used, the output signal level will be reduced. The NT6 output is balanced between pin 2 (hot) and pin 3 (cold). Pin 1 is ground.

Mounting your NT6

The NT6 is supplied with a selection of fittings and adaptors designed to ease positioning and mounting. The NT6 head attaches to a 2-axis swivel-mount that allows it to independently move and lock in position (see fig. 1)



fig. 1

To further increase the versatility of the NT6, it comes supplied with 2 threaded adaptors, a 1/4" to 5/8" and a 1/4" to 3/8" that enable the capsule assembly to be securely attached to a wide variety of mic stands, tripods and boom poles (see fig. 2)



fig. 2

The larger Adaptor is the 1/4" to 5/8". When screwed into the base of the swivel mount it enable the capsule assembly to be attached to a standard 5/8" thread found on microphone stands.

RØDE NT6

Mounting your NT6 - cont.

The smaller 1/4" to 3/8" adaptor, when screwed to the base of the swivel mount enables the head assembly to be attached to a standard tripod or Boom Pole.

With the capsule securely in position, you are ready to connect and position the pre-amplifier (body) as required.

Like the head, the pre-amplifier is designed to be positioned and/or mounted in several ways.

The NT6 comes complete with an RM5 Stand Mount (see fig. 3).

When connected to a mic stand the RM5 securely holds the pre-amplifier in position. This allows the head assembly to be directly suspended from or positioned independently to that of the pre-amplifier.



fig. 3

As long as the pre-amplifier is suitably protected from the elements it can be positioned as required.

Before placing the pre-amplifier into the RM5 stand mount, remove all cables and connectors to eliminate the possibility of damaging the connectors.

Place the pre-amplifier into the RM5 by pushing the mic in on an angle, coming in from the back (see fig 4 & 5).



fig. 4



fig. 5

You will notice the holder is quite firm. This is intentional so as to stop the pre-amplifier from coming loose. Ensure you leave the high-pass filter and Pad controls facing upwards to enable quick access (fig. 5).

As with any recording set-up it is best to explore the options you have available and use the product within these constraints.

RØDE NT6

Connecting your XLR cable

The NT6 offers a balanced microphone level output and is wired as follows:

Pin 1 "earth", Pin 2 "+" and Pin 3 "-".

Make sure you use a high quality low loss XLR cable that is as short as practical to avoid losses and distortion.



fig. 6



fig. 7

To connect the XLR to the back of the pre-amplifier align the slot on the XLR connector to the groove on the inside of pre-amplifier body and insert. Ensure that the connector can not be removed without depressing the release button. (see fig. 6 and fig. 7).

Connecting the miniature cable

With the head and pre-amplifier in position and the XLR cable connected to the back of the pre-amplifier, it is time to connect the mini-XLR connectors.

With the pre-amplifier assembly in one hand and the mini-XLR in the other, align the key on the connector to the groove on the back of the pre-amplifier. Gently insert the connector ensuring you align the 2 elements correctly, without applying excessive force during insertion (see fig. 8 & 9).



fig. 8



fig. 9

The same method is to be used when attaching the min-XLR to the back of the head assembly.

RØDE NT6

Connecting the miniature cable - cont.

With the head assembly in one hand and the mini-XLR in the other, align the key on the connector to the groove on the back of the capsule. Gently insert the connector ensuring you align the 2 elements correctly, without applying excessive force during insertion (see fig. 10 & 11).



fig. 10



fig. 11

NT6 Controls

Now that you have the NT6 securely fastened to a mic stand or tripod etc., and the audio output XLR and mini-XLR are connected, you are ready to fine tune your setup.

The pre-amplifier (body) incorporates 2 2-position switches for varying both the low end frequency response (HPF) and sensitivity (Pad) (see fig. 12, 13 & 14 below).

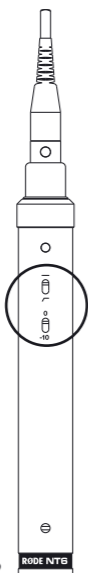

fig. 12



fig. 13 - High Pass Filter Control

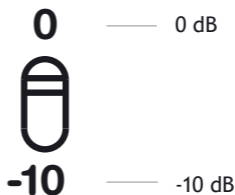

fig. 14 - Pad Control

RØDE NT6

NT6 Controls - cont.

The Pad settings provide a 10 dB reduction in sensitivity or commonly referred to as attenuation, and a 2-position variable high-pass filter that enables you to step from a flat response to 80 Hz high pass filter; both conveniently located away from the head, providing additional control without the need to move the head once in position.

Use the high pass filter when you wish to remove low frequency noise that is not part of your intended sound source.

Remember however the tonal characteristics will be affected by this, so it is important that you listen to the sound with and without the HPF in circuit before deciding if it is appropriate for the source.

A small screwdriver or pen can be used to alter the switch positions as required.

Miniature connection cable

The cable connecting the head to the pre-amplifier (body) is a custom 3 m Kevlar® fibre reinforced 3-pin cable.

The cable is designed to effectively support the combined weight of the capsule and body if required.

Cable runs of no greater than 10 m (30') are recommended to maintain signal integrity.

Signals:

pin 1 = Vcc

pin 2 = Signal

pin 3 = - HT (diaphragm bias voltage)

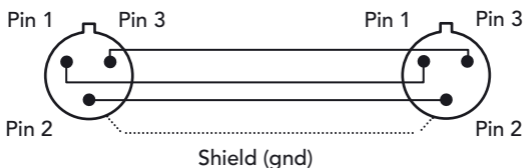

Connector
Front View
- Female

Connector
Front View
- Female

Miniature connection cable - cont.

The miniature connection cable is more than capable of withstanding the rigours of professional use, however it is important to understand and where possible consider the following points:

- The miniature connection cable is Kevlar® fibre reinforced and designed to withstand considerable tensile and compressive forces, however inside this sheath are 3 copper wires.
- Always ensure the connectors are correctly aligned groove-to-key when connecting the miniature connector's and do not use excessive force when inserting and withdrawing.

Interchangeable capsules

To further enhance the versatility of the NT6, RØDE has a range of interchangeable capsules that enable the response pattern to be tailored for specific applications.

The RØDE NT45 series of interchangeable capsules are available in Omni, "flat response" Cardioid, Hyper Cardioid and the as supplied "presence peak" Cardioid.

Designed and manufactured in Australia, the NT45 series offer low noise and distortion as well as high SPL capabilities. Contact your local dealer or visit the RØDE website for more details - www.rodemic.com.

NT6 Applications

The NT6 is intended for Film, Television, Broadcast, Live Performance, Theatre, Surround and Environmental recording applications; or wherever your imagination takes you.

RØDE NT6

NT6 windshield

The NT6 is supplied with a WS5 foam wind shield (see fig. 15 & 16).



fig. 15



fig. 16

The wind shield should be attached over the capsule when ever it is used or positioned in the slightest breeze, as this can cause sound interference. When using the mic outside in heavy winds you may need to purchase a more specialised wind shield.

Accessories

RØDE has a full line of accessories such as wind shields, boom poles etc., so contact your local dealer or visit the RØDE website for more details - www.rodemic.com.

RØDE NT6

Warranty Service

The **RØDE** NT6 is warranted for **ten years** from the date of purchase and your purchase should be recorded on-line at www.rodemic.com in the Product Registration section provided.

The warranty covers parts and labour that may be required to repair the microphone during the warranty period.

The warranty excludes defects caused by normal wear and tear, modification, shipping damage, or failure to use the microphone as per the instruction guide.

If you experience any problems or have any questions regarding your **RØDE** microphone, first, contact the dealer who sold it to you. If the microphone requires factory authorized service, that dealer will organise return.

We have an extensive distributor/dealer network but if you have difficulty getting the advice or assistance you require, do not hesitate to contact us directly or contact your local distributor.

Contact Details

International:

RØDE Microphones
ABN 91 000 576 483

107 Carnarvon Street
Silverwater N.S.W
2128 Australia.

P.O. Box 6685
Silverwater N.S.W
2128 Australia.

Ph: 61 2 9648-5855

Fax: 61 2 9648-2455

USA:

RØDE Microphones

P.O. Box 3279
Torrance, CA 90510-3279

Ph: 877 328 7456
(Toll free within the U.S.)

Ph: 310-328-7456

Fax: 310-328-7180

Website:

www.rodemic.com

RØDE[®]
MICROPHONES

