

SHURE®

LEGENDARY
PERFORMANCE™

SCM820 Digital IntelliMix® Automatic Mixer

USER GUIDE



27A20290 Rev. 4
©2017 Shure Incorporated

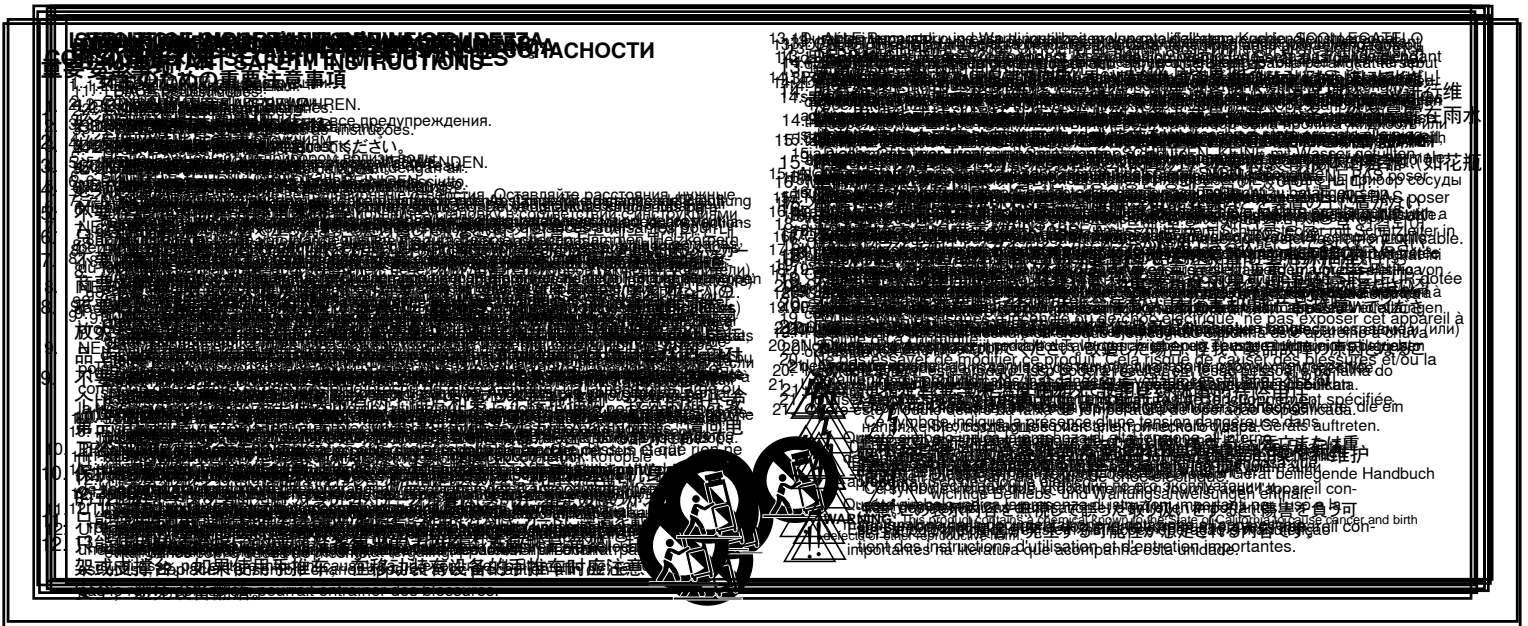

Important Product Information

The equipment is intended to be used in professional audio applications.

Note: This device is not intended to be connected directly to a public internet network.

EMC conformance to Environment E2: Commercial and Light Industrial. Testing is based on the use of supplied and recommended cable types. The use of other than shielded (screened) cable types may degrade EMC performance.

Changes or modifications not expressly approved by Shure Incorporated could void your authority to operate this equipment.

This Class B digital apparatus complies with Canadian ICES-003. Cet appareil numérique de la classe B est conforme à la norme NMB-003 du Canada.

Authorized under the verification provision of FCC Part 15B.

Please follow your regional recycling scheme for batteries, packaging, and electronic waste.

Information to the user

This equipment has been tested and found to comply with the limits for a Class B digital device, pursuant to Part 15 of the FCC Rules. These limits are designed to provide reasonable protection against harmful interference in a residential installation. This equipment generates uses and can radiate radio frequency energy and, if not installed and used in accordance with the instructions, may cause harmful interference to radio communications. However, there is no guarantee that interference will not occur in a particular installation. If this equipment does cause harmful interference to radio or television reception, which can be determined by turning the equipment off and on, the user is encouraged to try to correct the interference by one or more of the following measures:

- Reorient or relocate the receiving antenna.
- Increase the separation between the equipment and the receiver.
- Connect the equipment to an outlet on a circuit different from that to which the receiver is connected.
- Consult the dealer or an experienced radio/TV technician for help.

Patent Notice

U.S. Patent 5,999,631

Other patents pending

Table of Contents

Table of Contents	1	Dante Software by Audinate	14
Overview	2	Dante Controller	14
IntelliMix® Operating Principles	2	Dante Virtual Soundcard	14
Mixer Modes	2	Application Examples	15
Dual Mixer Operation	2	Creating a Link Group	15
DFR and Audio Processing	2	Integrating with Other Systems	15
Networking	2	Configuring for Use with a Choir	15
Model Variations	2	Internet Calling	16
		Logic	16
SCM820 Description	3	Digital Feedback Reduction (DFR)	17
Front Panel	3	Function	17
Rear Panel	4	Basic DFR Setup	17
		Assigning DFR	18
Signal Path Diagram	5	Filter Types	18
Operating the Mixer	6	Filter Width	18
Front Panel Modes	6	GUI Description	19
Audio Mute and Bypass	6	Navigation Bar	19
Monitoring	6	Input Tab	20
		Intellimix Tab	21
The SCM820 Graphical User Interface	7	Digital Feedback Reduction (DFR) Tab	23
Graphical User Interface (GUI)	7	Output Tab	24
Accessing the GUI	7	Link Group Tab	25
		Preferences Tab	26
Installation	8	Log On Page	28
Rackmounting	8	Troubleshooting	29
Power	8	Event Log	30
Typical Audio Connections	8	Front-Panel Error Messages	30
Furnished Accessories	8	Specifications	31
Configuring the Inputs and Outputs	9	Analog Connections	31
		Digital Signal Processing	31
Setting IntelliMix	10	Networking	31
Mixer Mode Descriptions	10	IP Ports and Protocols	32
IntelliMix Parameters	11	Connector Diagrams	33
Selecting the Mixer Mode	11		
Single or Dual Mixer Operation	11		
Networking	12		
Network Overview	12		
Digital Audio Networking	12		

The Shure SCM820 is an 8-channel digital automatic mixer designed for use in speech applications, including sound reinforcement, broadcasting and audio recording. It dramatically improves audio quality in any application where multiple microphones are required. The mixer uses IntelliMix® technology to select channels to open to the mix bus, while attenuating other channels. The mixing mode is selectable to allow a range of automatic mixing styles.

IntelliMix® Operating Principles

Expanding upon Shure's classic SCM810 IntelliMix technology, the digital SCM820 delivers seamless automatic mixing by combining the following functions:

- **Noise Adaptive Threshold (NAT)** manages the audio system by distinguishing between dynamic audio (such as speech) and the noise floor (such as air conditioning). It continuously adjusts the activation threshold, so that only speech levels louder than the background noise open a channel.
- **MaxBus** ensures that only one channel is opened per sound source, reducing comb filtering for clear, intelligible speech.
- **Number of Open Microphones Attenuation (NOMA)** attenuates system gain as additional channels are opened, providing consistent output levels and better gain before feedback.
- Maintains the perceived ambient sound to achieve a natural sounding audio program even during long pauses in conversation.

Mixer Modes

The mixer operates in one of five Mix Modes: Classic, Smooth, Extreme, Custom or Manual. The first three are factory settings that offer a range of reliable automixing styles. IntelliMix is configurable in Custom mode and turned off in Manual mode.

Classic

Classic mode emulates the default settings of the classic Shure SCM810 automixer. It is renowned for fast-acting, seamless channel gating and consistent perceived ambient sound levels.

Smooth

Smooth mode dynamically balances system gain between open and closed channels. The system gain remains consistent by distributing gain across channels to equal one open channel. This mode incorporates IntelliMix operating principles into a gain sharing mixing style.

Extreme

Extreme is an aggressive variation of Classic mode, configured to achieve maximum gain before feedback by completely attenuating closed channels.

Custom

Custom mode allows individual IntelliMix parameters to be fine-tuned and tailored from the GUI.

Manual

Manual mode deactivates IntelliMix to operate as a standard mixer. Channel and mix equalization, output limiter and mix bus routing are still active in this setting.

Dual Mixer Operation

The SCM820 can operate as a single or dual mixer:

Single Mixer: Channels are routed to a single mix bus that sends the same audio to both Mix A and B outputs. This allows the same program to be sent to different rooms or recording applications. Output gain, parametric equalizer and limiter can be set separately for each mix.

Dual Mixer: Two separate buses provide independent automixes for each mix output. This allows two entirely different mixes to result from the same set of inputs. This is useful when the mixer is being used for two applications. For example, set Mix A to Classic mode for sound reinforcement, and set Mix B to Smooth for a broadcast feed. As a dual mixer, channels can be routed to Mix A, Mix B, Mix A and B, or neither mix bus.

DFR and Audio Processing

The SCM820 features two channels of Digital Feedback Reducer (DFR). DFR uses Shure's patented Adaptive Notch Filter algorithm to detect feedback and deploy up to 16 narrow-band notch filters, dramatically improving gain-before-feedback in a sound reinforcement system. DFR can be applied to any two channels of the SCM820, including the mix outputs.

Additionally, the mixer provides adjustable input equalization, limiting and a parametric output EQ to optimize the sound in any application.

Networking

Dante™ Digital Audio

Digital audio is carried over standard Ethernet using shielded Cat5e (or higher) cables. Dante provides low latency, tight clock synchronization, and high Quality-of-Service (QoS) to provide reliable audio transport to a variety of Dante devices. Dante audio can coexist safely on the same network as IT and control data, or can be configured to use a dedicated network.

Audio can be played or recorded to a PC or Mac using Dante Virtual Soundcard (DVS), using the computer's standard Ethernet connection.

Remote Control

The SCM820 can connect to a computer or 3rd party control system (AMX, Crestron) for remote control and monitoring. The web browser-based graphical user interface (GUI) enables custom IntelliMix configuration and access to additional features.

Linking Mixers

SCM820-DAN mixers can be linked to form large automixes of up to 12 units (96 channels of audio). Mixers in the same link group operate under shared IntelliMix settings. A back-panel auto link button enables mixers to automatically link when they join the network. To link specific mixers, custom groups can be created and managed from the GUI.

Model Variations

The following table describes the four SCM820 model variations:

Model	Description	
	Connector Type	Network Card
SCM820	Block	Standard Ethernet
SCM820-DAN	Block	Dante Digital Audio
SCM820-DB25	DB25	Standard Ethernet
SCM820-DAN-DB25	DB25	Dante Digital Audio

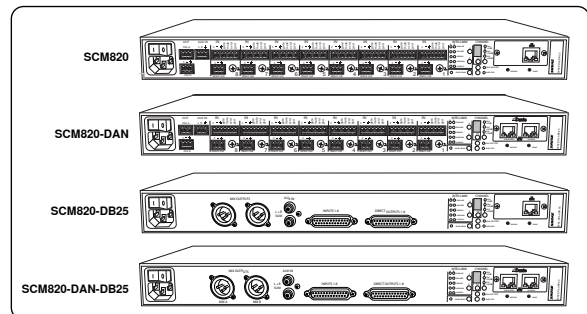

Upgrading to Dante

SCM820 Description

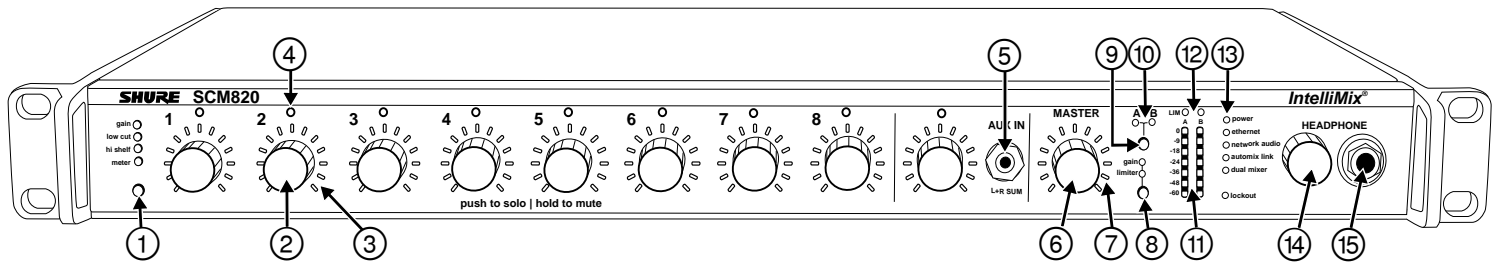

Front Panel

① Channel Mode Selection

Press the button to select the function of the channel knobs and monitor LED rings. See the Audio Signal Adjustment section for details on each mode.

② Assignable Channel Knob

Adjusts settings and status for each input:

Rotate: Adjusts a setting.

Momentary Press: Solos the channel to the headphone output.

Press and Hold: Mutes the audio or bypasses the EQ setting.

③ Monitor LED Ring

13 LED segments display gain setting, input signal meter, IntelliMix gain meter, channel solo, or EQ setting.

④ Channel Status LED

LED	Channel Status
Off	Channel is closed (attenuated in the automix).
Green	Channel is open (selected in the automix).
Amber	Channel EQ is bypassed.
Flicker Red	Signal is clipping. Set the channel to a lower input gain level.
Solid Red	Channel is muted.

⑤ Auxiliary Input Jack (1/8")

Unbalanced aux input sums left and right channels to mono. Front and back panel aux inputs are summed to a mono signal and routed **without automixing** to the mix outputs.

⑥ Master Output Knob

Adjusts settings and status of the mix outputs. See Front Panel Modes for details.

Rotate: Adjusts output gain or limiter threshold.

Momentary Press: Overrides a soloed channel to return the mix to the headphone output.

Press and Hold: Mutes the audio or bypasses the limiter.

⑦ Master LED Ring

Displays gain setting or limiter threshold. A single LED represents each mixer when they are both selected but set to different levels.

⑧ Master Mode Selection

Selects the function (gain or limiter) of the master knob and LED ring.

⑨ Mix Select Button

Selects Mix A, Mix B, or both for adjustment with the master knob and monitoring on the LED ring and headphone output. **Note:** When both Mix A and Mix B are selected, the headphone output only monitors Mix A.

⑩ Mix Status Indicator

LED	Mix Status
Green	Mix is selected for adjustment and listening on the headphone output.
Amber	Limiter is bypassed.
Red	Mix is muted.

⑪ Audio Output Meters

Monitor the output signal level and limiter threshold for mix A and B.

⑫ LIM (Limiter) LEDs

Illuminate amber when the audio levels exceed the limiter threshold.

⑬ System Status Indicators

The LEDs illuminate to indicate system settings:

LED	Color	Status
power	Green	Unit is powered on.
ethernet	Green	Unit is connected to a network.
network audio	Green	All connected receive channels are OK (receiving digital audio as expected).
	Flashing Green	One or more connected receive channels experiencing a subscription error or is unresolved (transmitting device is off, disconnected, renamed or has incorrect network setting).
	Red	Clock synchronization problem.
automix link	Off	No receive channels connected (routing has not been established).
	Green	Two or more mixers are connected in a link group.
	Flashing Green	Link Group is configuring.
dual mixer	Off	Mixer is in standalone mode.
	Green	Mixer is set to Dual Mixer operation.
lockout	Off	Mixer is set to Single Mixer operation.
	Red	Front panel controls are locked.
lockout	Flashing Red	An adjustment is attempted in lockout mode.

⑭ Headphone Volume Knob

Adjust the volume of the headphone output.

⑮ Headphone Output Jack (1/4 in.)

Monitor a mix or a soloed channel.

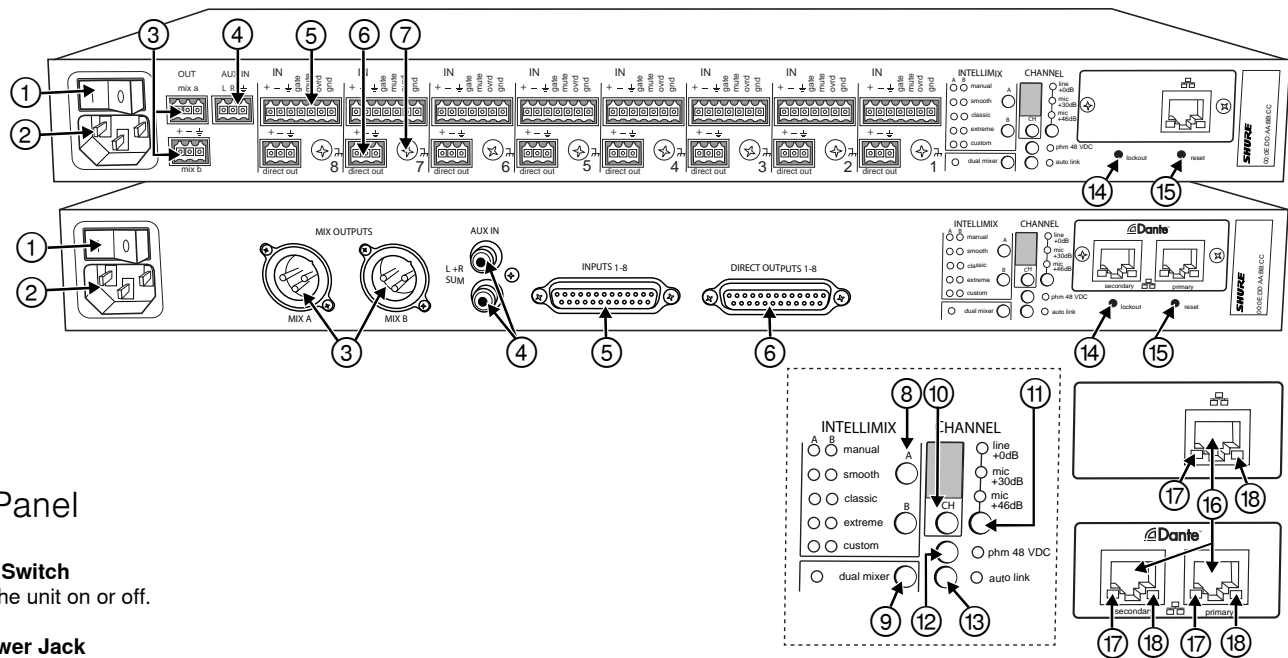

Rear Panel

- ① **Power Switch**
Turns the unit on or off.
- ② **AC Power Jack**
Supplies AC power to the mixer when plugged into a power source.
- ③ **Mix A and Mix B Outputs**
Active balanced outputs connect to amplifiers, DSP, mixer, or recording device.
- ④ **Auxiliary Input Jack**
Unbalanced aux input sums left and right channels to mono. Front and back panel aux inputs are summed to a mono signal and routed **without automixing** to the mix outputs.
- ⑤ **Channel Inputs 1–8**
Active-balanced microphone- or line-level inputs.
Block Connectors
+ : Audio +
- : Audio -
⏏ : Audio ground
gate: Logic gate out
mute: Logic mute in
ovrd: Logic override in
gnd: Logic ground
DB25 Connector
Pins: Audio plus, audio negative and audio ground. See Specifications for details.
- ⑥ **Direct Outputs 1–8**
Each channel has a dedicated, impedance-balanced direct output on the back panel that can be selected from one of five stages in the signal path. See Configuring the Inputs and Outputs for details on direct output routing.
- ⑦ **Chassis Ground Screw 1–8**
Provides an optional connection for microphone shield wire to chassis ground.
- ⑧ **IntelliMix Select Buttons**
Scrolls through IntelliMix presets for each mix output. When **dualmixer** is off, the A button sets the mode for both Mix A and Mix B.
- ⑨ **Dual Mixer Button**
Sets the SCM820 as a dual mixer, indicated by the green LED.
- ⑩ **Channel Select Button and Display**
Press to select a single channel (1–8) or all channels (A) when changing input gain or phantom power.
 - When all channels are selected (A), Input Level and Phantom Power LED indicators only illuminate if all channels have the same setting.
 - L is displayed when the mixer is in lockout mode.
- ⑪ **Input Gain Selection and LED Indicator**
Sets the analog input gain level for the selected channel(s), illuminating the green LED. All LEDs are off when the channel's audio source is set to Network from the GUI.
- ⑫ **Phantom Power Button and LED Indicator**
Supplies 48 VDC phantom power to the selected channel(s), illuminating the green LED. Phantom Power is disabled in the line (+0dB) gain setting.
- ⑬ **Auto Link Button and LED Indicator**
Enables networked SCM820-DAN mixers to automatically form a link group. Link Groups enable a larger audio mix by incorporating inputs from two or more mixers. See Link Groups for more details.
- ⑭ **Lockout Button and LED Indicator**
Hold for five seconds to disable front and back panel controls. The front panel **lockout** LED illuminates red (flashing red during an adjustment attempt) and the back panel channel display shows L.
- ⑮ **Reset Button**
Press and hold for five seconds to reboot the mixer with default system settings restored.
- ⑯ **Network Ports**
RJ-45 jacks for network connection.
- ⑰ **Network Status LED (Green)**
Off = no network link
On = network link established
Flashing = network link active
- ⑱ **Network Speed LED (Amber)**
SCM820:
Off = 10 Mbps
On = 100 Mbps
SCM820-DAN:
Off = 10/100 Mbps
On = 1 Gbps

Signal Path Diagram

The following diagram shows the audio signal path and the routing options for several features (default configuration shown). Use the GUI to change the configuration.

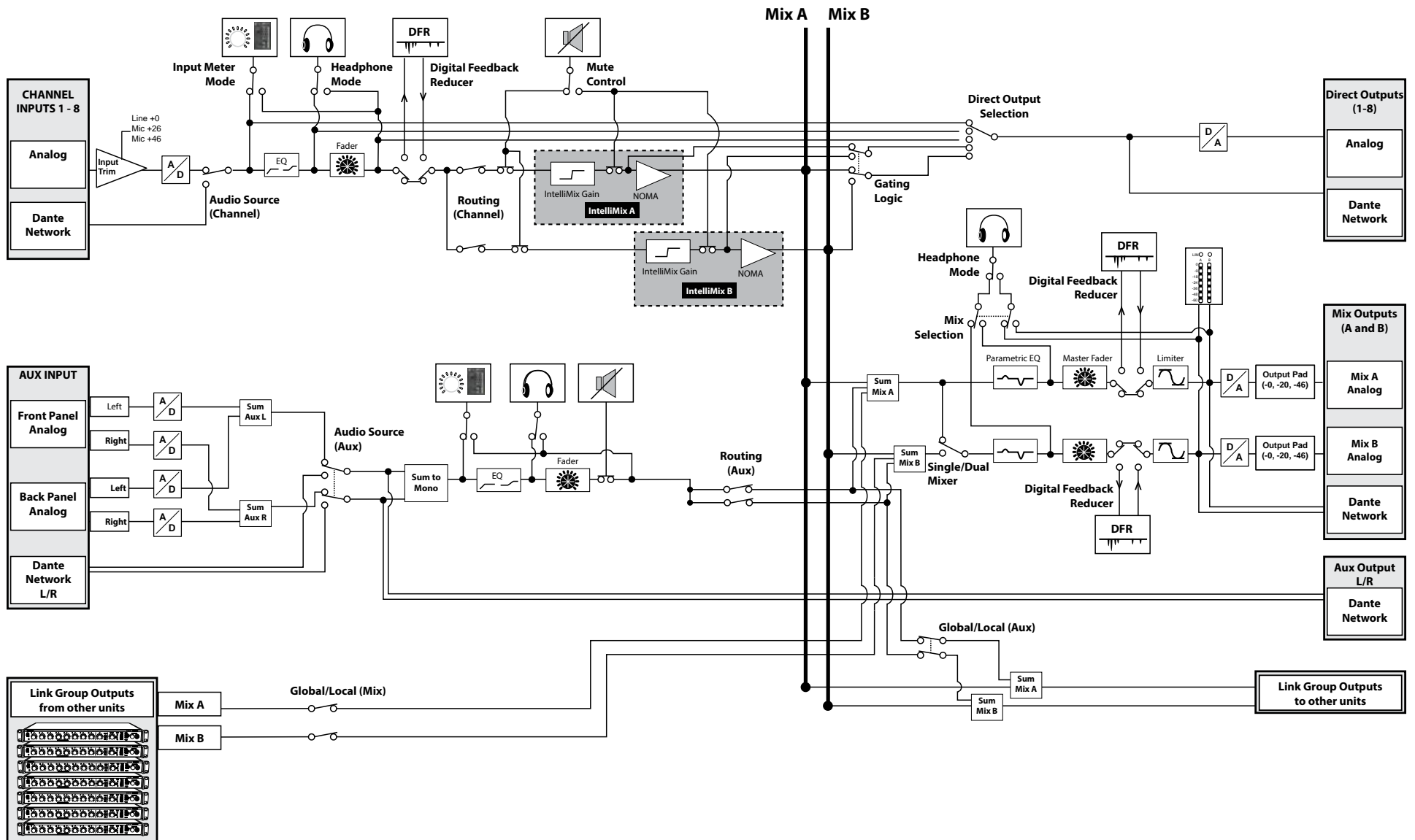

Front Panel Modes

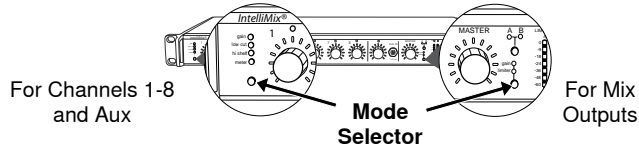

Channel Inputs

The channel knobs operate in five modes for different types of input signal adjustment and display. Use the front panel mode selection button to select from the following modes.

Channel Gain (gain)

Adjust gain within a 128 dB range while displaying the gain setting on the LED ring. Unity gain is at the 9th LED.

Low Cut (low cut)

Adjust the frequency of the low cut filter (6 dB/octave from 25 to 320 Hz). Use to remove low-frequency noise such as table vibrations or air-conditioning rumble.

High Shelf (hi shelf)

Adjust the high shelf boost or cut (± 12 dB at 5 kHz). Use to add presence to muddy vocals, temper sibilant vocals, or enhance the sound of off-axis lavalier microphones.

Input Signal Meter (ch. meter)

LEDs display the input signal level in real-time. Channel gain is adjustable in this mode, and will momentarily display channel gain setting during adjustments.

IntelliMix Gain Meter (gain and ch. meter)

LEDs display the IntelliMix attenuation applied in realtime. Channel gain is adjustable in this mode, displaying the setting on the LEDs during adjustments.

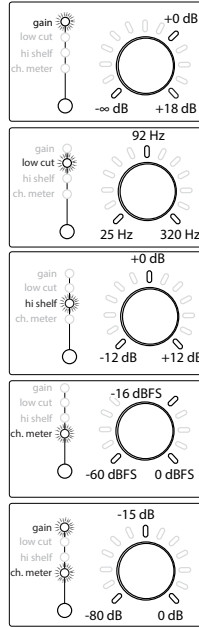

Mix Outputs

The mix output knob operates in two modes to control the mix output. Use the master function button to select one of two modes.

Output Gain (gain)

Rotate to adjust the output gain of the selected mix. The output signal level is displayed on the meters.

Limiter Threshold (limiter)

Rotate to adjust the limiter threshold of the mix (-2 to -50 dBFS). The limiter threshold level is displayed on the meters.

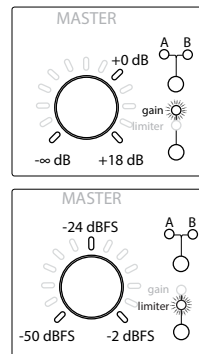

Audio Mute and Bypass

Mute Channel Input

Press and hold the input channel knob while in **gain** or **ch. meter** mode. The channel status LED turns red.

Mute Mix Output

Press and hold the **MASTER** knob while in **gain** mode. The mix status LED turns red.

Bypass Input EQ

Press and hold the input channel knob while in **low cut** or **hi shelf** mode. The channel status LED turns amber.

Bypass Output Limiter

Press and hold the **MASTER** knob while in **limiter** mode. The mix status LED turns amber.

Monitoring

Headphone Output

Use the front panel headphone jack for monitoring audio. By default, the headphones monitor the mix pre-fader/post-EQ (change to post-fader/post-limiter from **GUI > Preferences Tab**).



Solo to Headphones

A channel can be soloed to the headphone jack.

Solo Channel: Press a channel knob to solo that channel to the headphones. The other LED rings dim to highlight the soloed channel.

Exit Solo: Press the soloed channel knob or press the **Master** knob to return the mix to the headphones.

Input Meters

The front panel channel meters can be set to display real-time signal information. Use the front panel mode selection button to scroll to the desired mode:

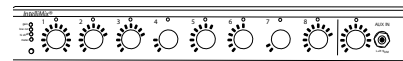

Input Signal Level

The channel meter mode (**ch. meter**) displays real-time audio input signal level for each channel.

IntelliMix Gain

The IntelliMix meter mode (**gain** and **ch. meter** illuminated) displays IntelliMix gain operation in real-time across the channel LEDs. Channels that gate open will display more gain than channels that are closed (attenuated) in the mix.

Output Meters

The output meters indicate the level of each mix before the digital-to-analog conversion. By default, the meter displays average and peak audio levels. It is good practice to use -18 dBFS on the SCM820 meter as an approximation of 0 VU on an analog meter.

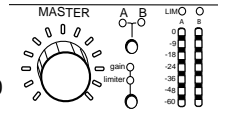

LED	Description	Signal Level (dBFS)
Red (7)	Clip	0 to -6
Yellow (6)	Normal peaks	-6 to -9
Yellow (5)		-9 to -18
Green (4)	Signal Present	-18 to -24
Green (3)		-24 to -36
Green (2)		-36 to -48
Green (1)		-48 to -60

Changing the Metering Type

Go to the Preferences tab of the GUI to change the following metering options:

- **Meter Type:** Change the input and output meters from displaying VU + Peak (default) to VU or Peak.
- **IntelliMix Gain Metering:** The Input tab of the GUI can display input signal level (default) or IntelliMix gain metering in realtime.

Graphical User Interface (GUI)

The SCM820 graphical user interface (GUI) enables comprehensive control of the mixer from a web browser. The GUI is hosted from a webserver embedded on the SCM820, and is accessible from any computer on the network. Use the GUI for the following functions:

- Manage mixers from a remote location.
- Customize IntelliMix parameters.
- Form large automixes with custom link groups.
- Assign the direct outputs in the signal path.
- Configure Redundant or Split networks.
- Set up and monitor DFR for up to two channels in each mixer.



Accessing the GUI

The Shure Web Server Discovery application finds all Shure devices on the network that feature a web-based GUI. Follow these steps to install the software and access the SCM820 GUI:

- 1
- 2 **Connect the network**
Ensure the computer and the mixer are on the same network.
- 3 **Launch the Discovery application**
The app displays all Shure devices that feature a GUI.
- 4 **Open the SCM820 GUI**
Double-click on a device to open its GUI in a web browser.
- 5 **Bookmark the GUI (recommended)**
Bookmark the device's DNS name to access the GUI without the Shure Discovery app.

System Requirements

- Windows: Windows XP (32 and 64 bit), Windows Vista and Windows 7
- Apple: Mac OSX 10.6.0 and higher
- Latest version of Adobe Flash Player
- Bonjour software (bundled with the Shure Discovery app)
- The GUI is supported on the following web-browsers: Internet Explorer, Firefox, Safari and Chrome.

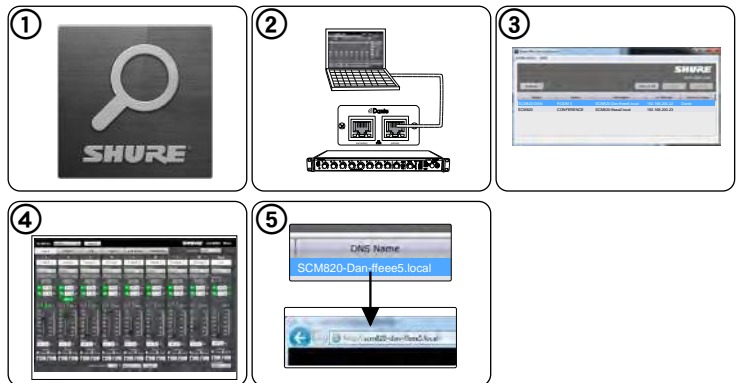

Accessing the GUI without the Discovery App

If the Discovery application is not installed, the SCM820 GUI can be accessed by typing the DNS name into an internet browser. The DNS name is derived from model of the unit (SCM820 or SCM820-DAN), in combination with the last three bytes (six digits) of the MAC address, and ending in **.local**.

Format Example: If the MAC address of a unit is 00:0E:DD:AA:BB:CC, then the link is written as follows:

- **SCM820-DAN:** <http://SCM820-DAN-aabbcc.local>
- **SCM820:** <http://SCM820-aabbcc.local>

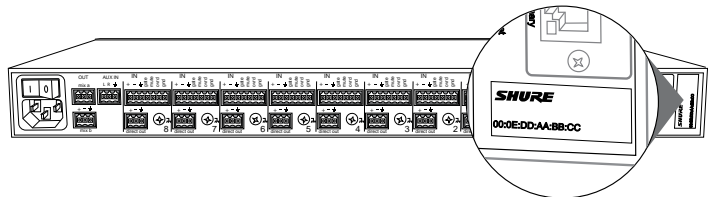

Power

Connect the unit to AC power using the supplied IEC cable. Turn on the power switch.

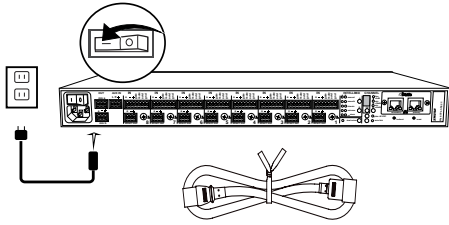

Rackmounting

Rackmount the mixer using the screws and washers supplied in the Hardware Kit. Follow these general best practices when rackmounting equipment:

- Ambient temperature of the rack should not exceed specified operating temperature range of the device.
- Keep fan inlet and side air vents clear from obstructions and provide adequate space for airflow within the rack.
- When possible, provide 1 RU of empty space between each device.

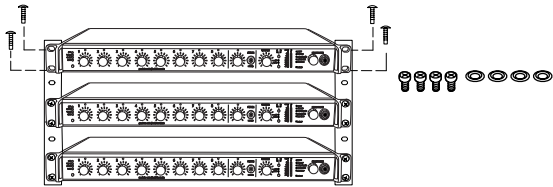

Furnished Accessories

Hardware Kit (SCM820, SCM820-DAN)	90A20082
Hardware Kit (SCM820-DB25, SCM820-DAN-DB25)	90BA8100
Ethernet cable	95D15103
Power Cable	region dependent, see table

Power Cable by Region	Part Number
US	95B8389
Brazil	95A14336
Argentina	95A14335
Europe	95C8247
UK	95A8713
Japan	95B9021
China	95B9073
Korea	95B9074
Australia	95A9128

Typical Audio Connections

① Channel Inputs

- Microphones
- Insert send from a mixer
- Dante network audio

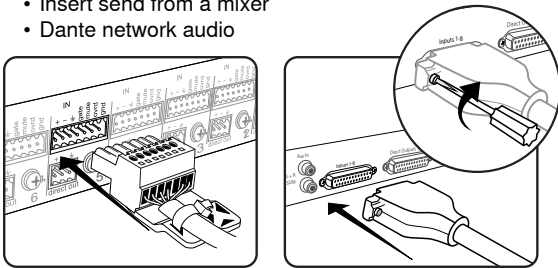

② Aux Inputs

Aux-level sound sources:

- MP3 player
- Computer headphone output
- CD player

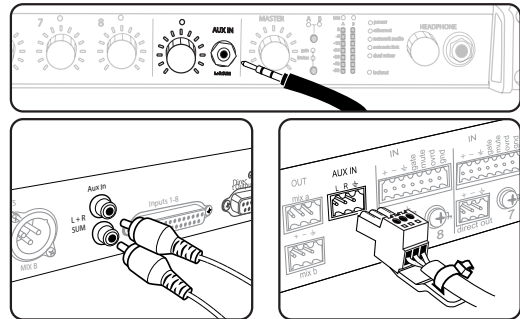

③ Mix Outputs

- Amplifier
- Powered speakers
- Mixer channel inputs

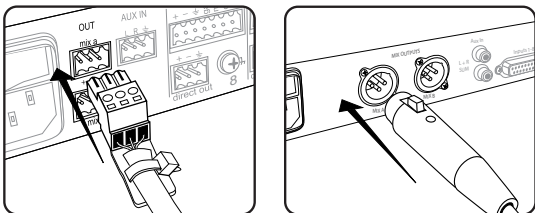

④ Direct Outputs

- Insert returns to a mixer
- Recording device
- Mixer channel inputs

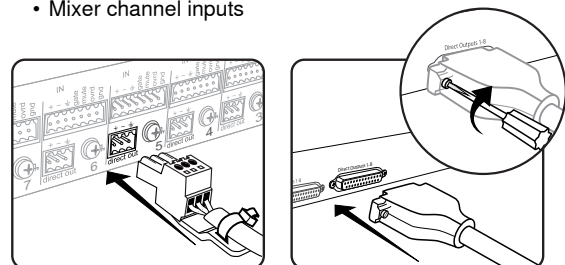

Configuring the Inputs and Outputs

Unless where noted, configurations can be made from the hardware or from the GUI.

Inputs

① Select the Audio Source (GUI only)

- Analog (default): Audio is from a microphone or line-level audio source connected to a channel input on the mixer back panel.
- Network: Audio is from the Dante digital audio network. Go to the Inputs tab of the GUI to select Network audio for each desired channel. Dante Controller software is required to properly route audio to the channel inputs.

② Select the Input Gain

Select the analog input gain for each channel. No gain is applied for analog line-level or when the audio source is set to Network.

- Mic (+46dB): For less sensitive microphones, such as dynamics.
- Mic (+26dB): For loud talkers or sensitive microphones such as condensers.
- Line (+0dB): For line-level sources such as mixer inserts.

③ Supply Phantom Power

Supply 48 V phantom power to the channel when using condenser microphones. (Phantom power is disabled when Input gain is set to Line.)

④ Adjust Channel EQ

Adjust the high- and low-frequency equalization to improve intelligibility and reduce undesired noise:

- Low Cut: Ideal for attenuating low-frequency vibration caused by table vibrations or air-conditioning rumble. Adjust the frequency of the 12 dB/octave filter from 25 - 320 Hz.
- High Shelf: For tempering sibilant speech or enhancing the sound of off-axis microphones. Use this to boost or cut the signal by 12 dB at 5 kHz with a slope of 12dB/octave.

Direct and Mix Outputs

⑤ Assign the Direct Outputs (GUI Only)

Assign the Direct Output for each channel from the Output tab of the GUI.

- Pre-EQ: After the Input Gain
- Post-EQ: After the EQ blocks
- Post-Fader: After the channel fader
- IntelliMix: After the IntelliMix gating decision
- IntelliMix NOMA: After IntelliMix gating and NOMA decisions

⑥ Set Mix Output Level (GUI Only)

Set the Output level according to the input of the connecting equipment:

- Line (-0) (default): No attenuation to the output level.
- Aux (-20): The signal is attenuated 20 dB to avoid clipping a line input.
- Mic (-46): The signal is attenuated 46 dB to match a microphone input.

⑦ Set the Limiter

The output limiter prevents distortion during loud program peaks without affecting normal program levels. This prevents overloading the devices connected to the mixer outputs.

⑧ Adjust the Output Gain

Adjust the overall output level of the mix.

Auxiliary (Aux) Input

The SCM820 features two auxiliary inputs: an 1/8" jack on the front panel and a back panel input (block connector or RCA connectors, depending on the model). Each input sums the left and right channel to a mono signal. This mono signal is routed directly to the mix outputs, bypassing the automixing process. Use this input for sources such as an MP3 player or computer speaker output.

Digital Channels

When the mixer is connected to a Dante network, the left and right channels are accessible before they sum to the mono signal for the mix outputs. Use the Aux L and Aux R channels in Dante Controller to route audio to and from the aux channel.

Setting IntelliMix

The SCM820 uses IntelliMix to select channels to open in a mix, while attenuating the gain of closed channels. IntelliMix is available in three presets and can be customized to excel in any application where multiple microphones are used at once. In all modes (except Manual), **MaxBus** ensures that only one channel is opened per sound source.

Mixer Mode Descriptions

The SCM820 features five mix modes: Classic, Extreme, Smooth, Custom or Manual.

Classic

Classic mode emulates the classic Shure SCM810 automixer (in its default settings). It is renowned for fast-acting, seamless channel gating and consistent perceived ambient sound levels. The Classic mode excels in most applications, specifically sound reinforcement and teleconferencing.

Gating Style:	Full
Gain Scaling:	Fixed
Off Attenuation:	-15 dB
Last Mic Lock On:	Enabled

Channel Gain in Classic Mixer

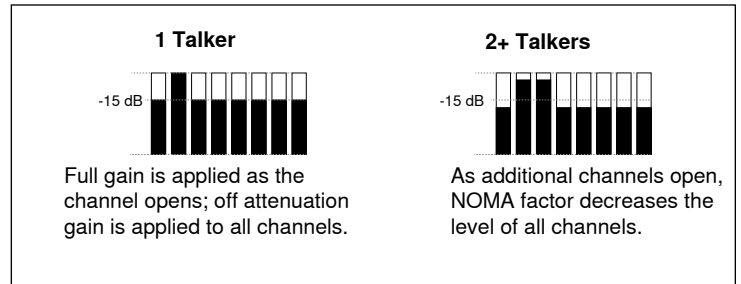

Smooth

Smooth dynamically balances system gain between open and closed channels. The system gain remains consistent by distributing gain across channels to equal one open channel. It incorporates IntelliMix operating principles into a gain sharing mixing style, making it ideal for broadcast and recording applications.

Gating Style:	Relative
Gain Scaling:	Adaptive
Off Attenuation:	Disabled
Last Mic Lock On:	Disabled

Channel Gain in Smooth Mixer

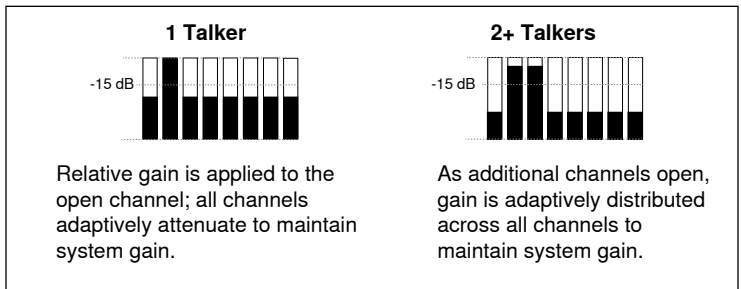

Tip: Unroute all unused channels to the mix bus. This will ensure the most consistent noise floor in Smooth mode.

Extreme

Extreme is an aggressive variation of the Classic mode, configured to achieve maximum gain before feedback by completely attenuating closed channels. Only open channels add to the system levels and ambient sound. Extreme mode is designed for sound reinforcement applications.

Gating Style:	Full
Gain Scaling:	Fixed
Off Attenuation:	-110 dB
Last Mic Lock On:	Disabled

Channel Gain in Extreme Mixer

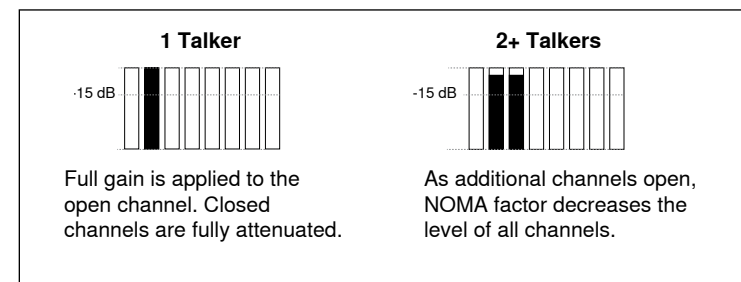

Manual

Manual mode deactivates IntelliMix to allow the SCM820 to operate as a standard mixer. All Channel Status LEDs remain on in this mode to indicate there is no IntelliMix attenuation. Channel and mix equalization, output limiter and mix bus routing are still active in this setting.

Tip: Be careful when switching to Manual mode, as all microphones will gate open to full gain, which may result in feedback.

Custom

Custom mode allows IntelliMix parameters to be fine-tuned and tailored from the GUI. The mixer automatically switches to Custom once a parameter is changed in Classic, Extreme or Smooth mode. These configurations are saved to the device and will persist after the mixer is turned off and restarted. Custom configurations can also be saved as a file to a computer and loaded onto the device for quick recall.

IntelliMix Parameters

Gating Style

Determines the way gain is applied to open channels.

Full

Channels open at full gain (as adjusted by the NOMA factor).

Relative

Channels open at a gain level that varies with the input signal level—quieter signals receive less gain than loud signals. As the input signal level increases, more gain is applied to the channel.

Gain Scaling

Determines off attenuation and its effect on the total system gain.

Fixed

Off attenuation is a fixed amount. Total system gain varies with the number of open channels.

Adaptive

Off attenuation is adjusted to maintain a uniform system gain comparable to that of a single open channel.

Off Attenuation

The amount of attenuation applied to closed channels.

Last Mic Lock On

Avoids ambient dropout by keeping at least one channel open at all times. The last channel opened remains open until another takes its place.

Number of Open Microphones Attenuation (NOMA)

System gain is attenuated as additional channels are opened in a mix. This is configured per doubling of open channels, adjustable from 1–6 dB for each mix that has Gain Scaling set to Fixed.

Maximum Number of Open Microphones (Max NOM)

Restricts the number of microphones that can be open at a time in a mix. This is adjustable from 1 ("filibuster mode") to maximum (unlimited).

Hold Time

Determines the minimum amount of time that a channel is gated open.

Selecting the Mixer Mode

Press the Mix A or Mix B button on the mixer back panel to scroll through the five modes. From the IntelliMix tab of the GUI, you can select a preset or configure the IntelliMix as a Custom setting.

Mixes A and B have the same IntelliMix settings when the SCM820 is in Single Mixer Operation (default).

Single or Dual Mixer Operation

The mixer can be set to perform one or two automixes:

- **Single Mixer (default):** Channels are routed to a single mix bus that sends the same audio to both Mix A and B outputs. Limiter and master gain can still be set independently for both outputs.
- **Dual Mixer:** Two separate buses provide independent automixes for each mix output. In this setting, two entirely different mixes can result from the same set of inputs.

Enable dual mixer operation by pressing the Dual Mixer button on the back panel or from **GUI > IntelliMix Tab**.

Example Dual Mixer Applications:

- Set Mix A to Classic mode for sound reinforcement, and set Mix B to Smooth for a broadcast feed.
- Mix A to Classic mode for sound reinforcement, and Mix B for Manual for recording.
- Route channels 1-4 to Mix A and 5-8 to Mix B to run independent automixes for two different locations from one device.

Back Panel

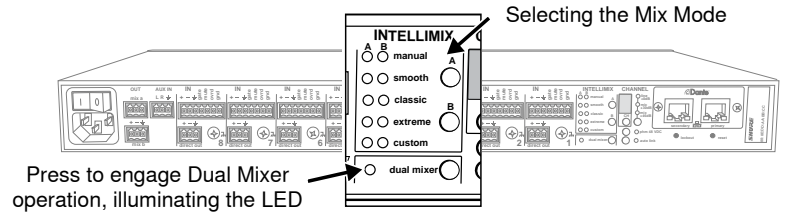

GUI

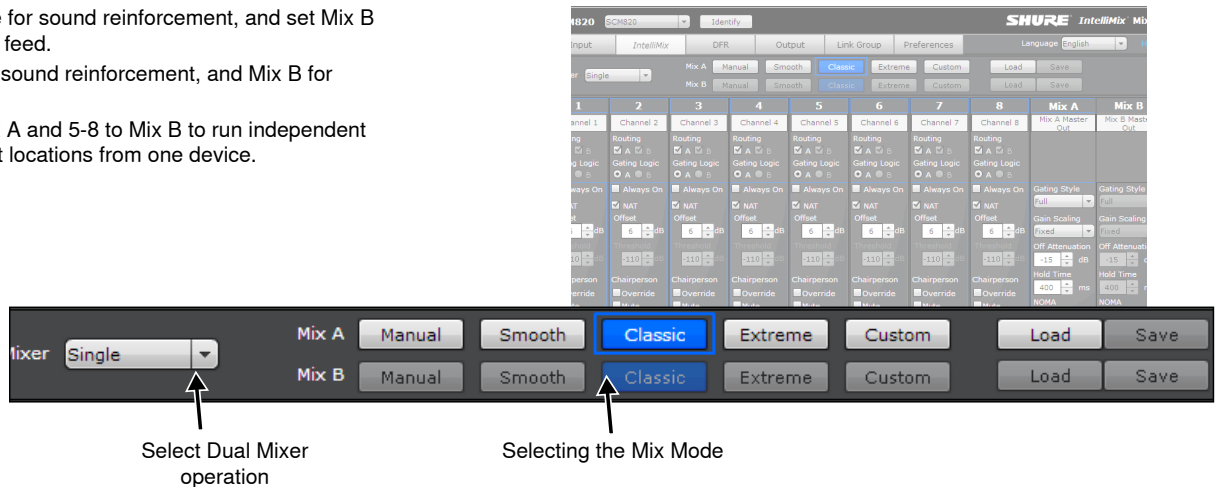

Network Overview

For most installations, the SCM820 can connect to a computer either directly or through a network switch ("Link-Local" connections). Connect multiple mixers to a switch in a star configuration to ensure reliable networking (each unit connects directly to the switch).

In some cases, computer settings or programs may interfere with the network. The majority of these connection issues can be solved by using a DHCP-enabled router*. Most routers include a DHCP server, while switches do not.

*Note: DHCP servers are not recommended for redundant network configurations. See Redundant Network Recommendations for more details.

Typical Network Setups

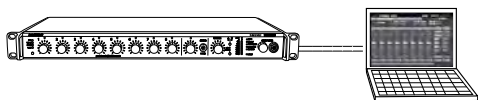

Single Mixer

The SCM820 can connect directly to a computer. (This setup may take a minute or longer to establish a connection between devices.)

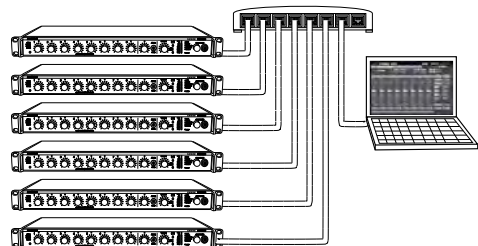

Multiple Mixers

Connect multiple mixers together in a star configuration using a DHCP-enabled router for the most reliable network setup.

Basic Networking Requirements

To network SCM820 mixers, ensure the setup meets the following requirements:

- Use shielded Cat5e cables (or higher)
- Cable runs limited to 100 m (328 ft.)
- Devices are on the same subnet

Network Best Practices

- Use gigabit ethernet devices
- Use only one DHCP server per network
- Turn off other network interfaces not used to connect to the mixer (including WiFi)
- All mixers must have the same level of firmware revision installed

Dante™ Digital Audio Networking

Dante™ digital audio is carried over standard Ethernet and operates using standard Internet Protocols. Dante provides low latency, tight clock synchronization, and high Quality-of-Service (QoS) to provide reliable audio transport to a variety of Dante devices. Dante audio can coexist safely on the same network as IT and control data, or can be configured to use a dedicated network.

Data Types on the Network

The SCM820 transports two types of data over the network: Shure Control and Dante Audio and Controller. They are transported to/from the two network ports depending on the mixer's network settings.

Shure Control: The Shure Control carries data for the GUI operation, firmware updates and 3rd party control systems (AMX, Crestron). This network is supported by all SCM820 models.

Dante Audio and Controller: The Dante network carries both the digital audio and the control data for Dante Controller. This network is supported by Dante-enabled SCM820s.

Dante Network Interface

The Dante network card is a two-port interface that can be configured to enable the following applications:

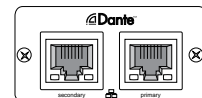

- Link mixers to expand the audio mix, enabling the addition of up to 12 mixers (96 channels).
- Protect the audio signal with a redundant audio network.
- Isolate Dante audio from the Shure Control network.
- Record audio to a computer without additional hardware.
- Maintain digital audio path to other Dante devices.
- Route an 8-channel automixing insert to another Dante device using a single shielded Cat5e cable.
- Daisy-chain up to four SCM820 mixers.

Switch Recommendations for Dante Networking

In addition to the basic networking requirements, Dante audio networks should use a Gigabit network switch or router with the following features:

- Gigabit ports
- Quality of Service (QoS) with 4 queues
- Diffserv (DSCP) QoS, with strict priority
- Recommended: A managed switch to provide detailed information about the operation of each network link (port speed, error counters, bandwidth used)

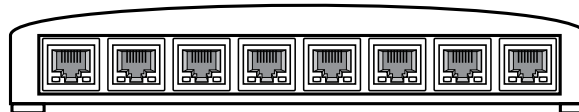

Network Modes

The Dante network interface can be configured to operate in one of three modes: Switched, Redundant Audio or Split. This setting determines the types of data that are transported from the Primary and Secondary ports.

Data Transport in each Mode

The following table displays the configuration of the Dante network ports in each Network Mode. **Note:** Always connect the Primary port to the network that is used for Shure Control.

Dante Port Configuration

Network Mode	Port Function		Application
	Secondary	Primary	
Switched (default)	Shure Control Dante Audio and Controller	Shure Control Dante Audio and Controller	Typical installations of star or daisy-chained networks.
Redundant Audio	Dante Redundant Audio	Shure Control Dante Audio and Controller	Create a backup audio network.
Split	Dante Audio and Controller	Shure Control	Isolate Dante and Shure Control networks

Caution: Disconnect the equipment from the network prior to changing the network mode. This will avoid a network loop that will make the network unstable.

Selecting the Network Mode

1. Disconnect the mixer from the network.
2. Connect the Primary port of the mixer directly to a computer.
3. Go to the Network in the GUI: **Preferences > Network**
4. Select the Configuration mode. The mixer will reboot once the selection is confirmed.
5. Repeat for each mixer.

Warning: Do not reconnect mixers to the network until the network configuration is the same for all units.

Network Configurations in Switched Mode (default)

Star Configuration (Recommended)

Connect multiple mixers to a router in a star configuration for the most reliable setup.

Star Configuration
(Recommended)

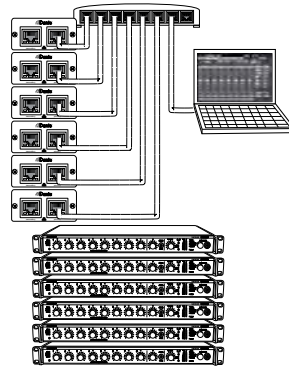

Daisy-Chain (up to 4)

Up to four SCM820-DAN mixers can network together by daisy-chain. This is only supported in Switched network mode (default).

Daisy-Chain

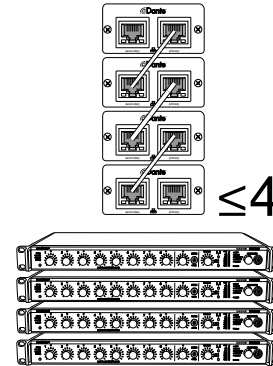

Direct to Computer

Connect the Primary port directly to a computer.

Direct to Computer

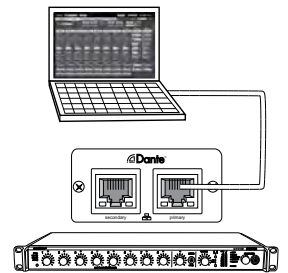

Warning: Do Not Make a Network Loop

Avoid the following setups that will render the network unusable:

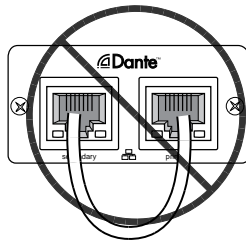

Do not connect the primary to the secondary port of the same device.

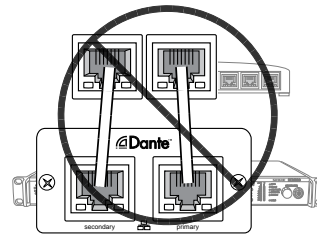

Do not connect the two ports to the same switch.

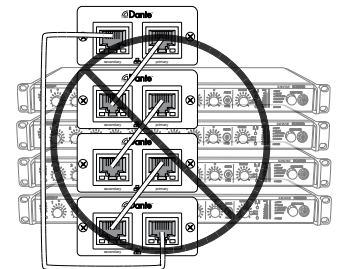

Do not connect mixers together in a loop.

Redundant and Split Networks

The Primary and Secondary ports require dedicated network switches in Redundant Audio and Split modes.

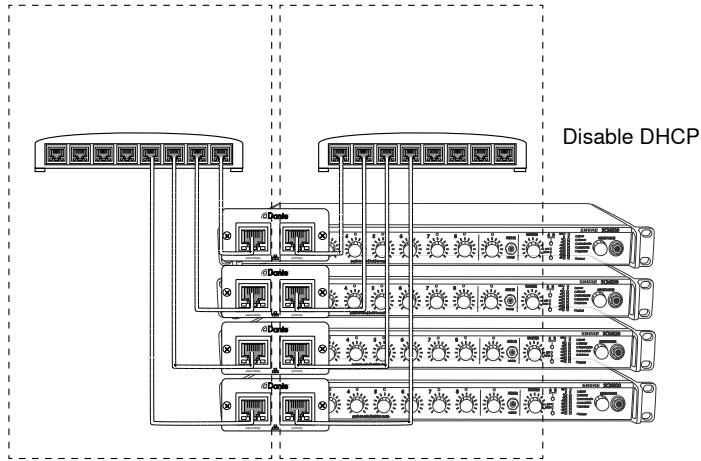

Isolated Networks for Each Port in Redundancy and Split Modes

Redundant Network Recommendations

For the most reliable Redundant network, it is recommended to set up both networks **without** a DHCP server. Connect each unit to a network switch without DHCP or to a router with DHCP disabled.

If it is not possible to disable the DHCP server, configure the mixer to a static IP address from the GUI (GUI > Preferences tab > IP Mode > Manual).

Note: Use caution when operating a Link Group in a Redundant network. If a Link Group goes down, there will be temporary audio loss **on both ports** while the group reconfigures.

Configuring a 100 Mbps Dante network

Gigabit equipment is strongly recommended for Dante network. If this is not possible, configure the 100 Mbps network with the following guidelines:

- Ensure the router has QoS enabled
- Latency settings are set to at least 1 ms

Caution: Do not form Link groups on a 100Mbps network, as this will cause increased traffic and will exceed the network bandwidth.

Setting Latency

Latency is the amount of time for a signal to travel across the system to the outputs of a device. To account for variances in latency time between devices and channels, Dante has a predetermined selection of latency settings. When the same setting is selected, it ensures that all Dante devices on the network are in sync.

The latency setting for Dante devices should be set according to the number of switches in the network. The SCM820 network card has an internal switch chip and counts as a switch. For example, one SCM820 connected to an external switch equals two switches.

Go to GUI > Preferences Tab to change the setting.

Latency Recommendations

Latency Setting	Maximum Number of Switches	
	1 Gbps Network*	100 Mbps Network
0.25 ms	3	-
0.5 ms (default)	5	-
1 ms	10	2
2 ms	10+	5

*Strongly Recommended

Dante Software by Audinate

Dante Virtual Soundcard

Dante Virtual Soundcard (DVS) software turns a computer into a Dante-enabled device, allowing digital audio traffic to be transmitted and received using the standard Ethernet port.

On Windows, DVS can select Steinberg's ASIO audio interface or Windows Driver Model (WDM). On Mac OSX, the DVS uses the standard Core Audio interface.

Dante Controller

Dante Controller (DC) is a free software program by Audinate that is used to configure and manage a network of Dante devices. Use it to route channels between Dante-enabled devices and to monitor the status of the device, clock, and network.

For proper functionality with the SCM820, use Dante Controller version 3.4.0.0 or higher. Go to Audinate's website for download and installation instructions.

Creating a Link Group

If additional channels are needed, multiple mixers can link together to create a larger automatic mix. To form a link, Dante-enabled mixers are connected to a gigabit network and assigned to a link group. This enables up to 12 mixers (96 channels) to contribute to the same mix from anywhere on the network.

Mixers in the same link group operate under shared IntelliMix settings. These settings are defined by the first mixer to join the group. When mixers are added, their IntelliMix and network settings are reconfigured to match the group's settings. IntelliMix settings can then be changed from any mixer, automatically updating the rest of the group.

Setting up a Link Group

Link Groups are managed from the Link Group tab of the GUI. Once a mixer joins a group, its front panel Network Audio and Automix Link LEDs will illuminate green. Up to 12 mixers can join a group at a time.

Ensure the Link Group setup meets the following requirements:

- Use SCM820 mixers with the Dante network card (SCM820-DAN or SCM820-DAN-DB25)
- Devices must be on the same subnet
- Use Gigabit (or higher) network switches to connect the devices. 100 Mb networks are not supported.
- Ensure the switches have at least 300 Mbps of available bandwidth for each device. Devices in a Link Group use more network bandwidth than Stand Alone devices.

Automatic Linking

The auto link setting enables SCM820s to automatically form a link group when they join the network. No additional setup from the GUI is required.

Select the **auto link** button on the mixer back panel. It automatically links to other mixers with this function enabled. Mixers with auto linking enabled will display in the Auto Link group in the GUI.

Note: Only the first 12 mixers that enable Auto-Link will join the group. If the group is full and an additional mixer attempts to enable Auto Link, it will remain as a Stand-Alone device.

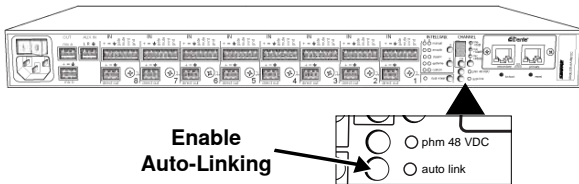

Custom Groups

To configure specific Link Groups, create a custom group in the GUI. Custom groups are helpful for managing multiple Link Groups across multiple mixers on the same network. To set up a Custom Group:

1. Open the Link Group tab of the GUI.
2. Click the New Group button create a group.
3. Name the group.
4. Drag and drop mixers to the group.



Setting Mix Outputs in a Link Group

The Local/Global setting determines whether each linked SCM820 Mix Output contains only its own program output, or that of all linked mixers. Go to the Output tab of the GUI to select the mix output.

Note: The Master level control is independent of the Local/Global setting. The output level and limiter setting of each mixer is affected only by its own Master control.

Global (default): All linked channels appear at the mixer outputs. This is the default setting for the mixer.

Local: Only its own eight input channels appear at the mixer's Mix Outputs.

Aux Channel

The aux channel can be set to Local or Global from **GUI > Inputs Tab**. Local Aux keeps the Aux signal from appearing on the mix output of other networked boxes

Integrating with Other Systems

DFR or External Equalizer

When using DFR channels or setting up a sound system an external processor/equalizer, begin by setting the SCM820 to Manual. This activates (gates open) all channels, so every possible feedback path is open.

After equalizing the sound system and "ringing out" the room with the feedback controller, set the mixer back to an IntelliMix mode.

Shure ULX-D Digital Wireless System

Shure ULX-D™ Digital Wireless offers uncompromising audio clarity and extremely efficient RF performance with rugged, intelligent, encryption-enabled hardware. The SCM820-DAN can provide automixing for the Dual or Quad ULX-D receiver by connecting to the Dante digital audio network.

As Channel Inserts

IntelliMix can be used as a processing insert on an analog console or over the digital audio network. Be sure to set the console inserts to post-fader. If this is not available, be sure to mute audio at the SCM820 in order to remove the signal from the automix.

Analog Insert

1. Connect the send from the mixer insert to the input of the SCM820.
2. Set the channel input to Line level (+0).
3. Connect return from the mixer insert to the direct output of the SCM820.
4. Set the direct output to IntelliMix NOMA.

Dante Insert

1. Open Dante Controller software.
2. Route the console sends to the SCM820 inputs.
3. Route the SCM820 direct outputs to the console returns.
4. Set the channel Source to Network from the Inputs tab of the GUI.
5. Set the direct output to IntelliMix NOMA on the Outputs tab.

Configuring for Use with a Choir

Use the SCM820 to manage a group of microphones that are providing sound reinforcement for a choir.

1. Connect microphones to the mixer.
2. Set the appropriate level for the microphones.
3. Open the IntelliMix tab of the GUI.
4. Select Classic IntelliMix mode.
5. Engage the Gate Group box for each choir microphone to ensure they gate open and closed at the same time. This will change the IntelliMix to Custom mode.
6. Increase the Hold Time for the Mix output to the maximum setting of 1500 ms.

Tip: If unnatural gating occurs during sustained notes, disable the Noise Adaptive Threshold (NAT) and manually set a gate threshold.

Internet Calling

Dante-enabled mixers integrate software applications such as Skype™, Lync™, Voice. This enables multiple microphones to participate in a teleconferencing event.

1. Reference the Installation section to properly connect and setup microphones to the mixer back panel.
2. Open the IntelliMix tab of the GUI.
3. Select Dual Mixer operation.
4. In the GUI, route channels 1 - 8 to Mix A only (deselect routing to Mix B).
5. In the Inputs tab, set the Aux channel to Network input source.
6. Route the Aux channel to Mix B only.
7. Open Dante Virtual Soundcard and turn it on.
8. Open Dante Controller (DC) software.
9. In DC, route the SCM820 tx channel 'Mix A' to computer rx channel 1.
10. In DC, route computer tx channels 1 and 2 to SCM820 rx channels Aux L and R.
11. Connect Mix B analog output to a speaker or output device.
12. Open the computer's settings and select Dante as the input and output soundcard.

Trademarks: Trademarks are the property of their respective owners.

Logic

The logic functions of the SCM820 expand the mixer's range of installation and control options. These functions can be hardwired or configured in the GUI.

The following hardware logic functions are available for each channel:

Gate Out

Follows channel gating and goes to logic "low" (sinks current) when microphone is gated on. 500 mA of current sinking ability is provided.

Mute In

Applying logic "low" (from GATE OUT or a switch closure to logic ground) gates channel off (channel output is fully attenuated).

Override In

Applying logic "low" (from GATE OUT or a switch closure to logic ground) forces channel on. When both Mute and Override are activated, Mute takes precedence.

Logic Ground

Logic ground is distinct from the SCM820 audio ground. Make all logic ground connections to this pin, including power supply ground of external logic circuitry. To avoid switch clicks, do not connect logic ground to audio, chassis or rack grounds.

Suggested Logic Application

This section contains suggestions on the uses of the SCM820's logic capabilities. For additional suggestions and solutions to installation problems, contact Shure's Systems Support.

Cough Button

The talker can turn off his or her microphone during coughing or private conversations by installing an SPST pushbutton switch between the MUTE IN and Logic Ground pins for each channel to be modified. When a channel is muted, no audio is passed.

Set the mute control to post-IntelliMix setting (GUI > IntelliMix Panel > Mute Control) to ensure that unwanted sounds do not gate on other microphones.

Chairperson-Controlled Muting

The chairperson can, by activating a switch, silence all other microphones and be heard without interruption.

1. Set the desired channel to Chairperson Mute to manual (GUI > IntelliMix Panel > Chairperson > Mute).
2. Connect the switch to the Override In logic connection for the chairperson's microphone.

An alternative to a switch is to set the Chairperson Mute to Auto. In this setting, when the chairperson's microphone activates, all other microphones mute automatically.

Remote Channel-Open Indicators

Remote indicators can be used to indicate when a talker's microphone is on. Connect the LEDs and a 5-volt supply to the GATE OUT pin. To avoid switching clicks in the audio output, do not ground the power supply negative terminal in the audio system or rack ground.

Important: If a single cable is used for the microphone audio signal and the LED dc power, separate shielded pairs must be used. Failure to carry the DC power on a shielded pair may result in audible clicking due to capacitive coupling between the DC power lines and microphone lines.

Disabling the Gating Function (Always On)

Select Always On for the channel(s) that should remain open (GUI > IntelliMix Panel > Always On).

Inhibiting Gating for Unwanted Sounds

The MaxBus operating principle ensures that the mixer will activate only one microphone per sound source. Muting a microphone channel prevents its audio from appearing at the mixer's output. However, the muted channel set to Post-IntelliMix still communicates with other mic channels via MaxBus. A sound source picked up by a muted microphone will not activate other microphones.

Sound sources that may cause unwanted microphone channel activation include:

- A noisy fax machine or printer
- A squeaky door
- An intercom system
- A teleconferencing loudspeaker

The SCM820 can prevent these and similar sounds from activating microphones by taking the following steps.

1. Place one microphone near the unwanted sound source. Connect that microphone's signal to a channel input.
2. Mute the channel.
3. Set the Mute Control to Post-IntelliMix (GUI > IntelliMix Tab > Mute Control).
4. Adjust that channel's gain control just to the level where other microphones in the system do not activate for the unwanted sound. If the channel gain is set too high, other system microphones will be difficult to activate for desired sounds. If set too low, unwanted sounds will continue to activate other microphones.

Loudspeaker Muting

Some applications require a loudspeaker to be placed near each talker to provide audio reinforcement, or to permit telephone conversation or conference monitoring. Each loudspeaker can cause feedback unless it is automatically switched off when the talker near it speaks. To provide this function, connect the GATE OUT terminal of each channel to a separate loudspeaker muting relay.

NOTE: A diode across each relay coil is required to suppress inductive voltage spikes which may damage the SCM820.

An alternative to creating a circuit is a Logic Controlled Relay, such as the Radio Design Labs (RDL) ST-LCR1.

"Filibuster" Mode

In normal operation, when several people talk, each microphone gates on so that no speech is missed. In "filibuster" action, a microphone that is gated on prevents other microphones from gating on. Once a microphone has gated on, other microphones cannot gate on until the talker has paused long enough for that microphone to gate off. Thus the person talking has the floor and cannot be interrupted.

Set the maximum number of open microphones to 1 (GUI > IntelliMix Panel > Mix A/B > MaxNOM)

Digital Feedback Reduction (DFR)

DFR uses Shure's patented Adaptive Notch Filter algorithm to discriminate between feedback and non-feedback sounds. It automatically detects feedback and deploys narrow-band notch filters at the feedback frequencies. DFR filters are narrow enough to prevent any coloration of the audio program.

No sound system (the combination of microphones, mixing, signal processing, power amplifiers, loudspeakers and room acoustics) produces an absolutely flat response. When the level of a sound system is increased, the frequencies at which peaks occur will be the first to exceed the threshold of feedback. The DFR attenuates these frequencies, flattening the response of the sound system and enabling operation at a higher overall level.

Function

Use DFR as the initial processor on any channel that receives signal from a live microphone where feedback is problematic. When DFR detects feedback, it inserts a shallow, narrow filter into the audio path to reduce gain at the feedback frequency. This filter is called a notch filter, due to the narrow section of the frequency spectrum it affects. The notch automatically deepens if feedback continues on that frequency.



Basic DFR Setup

Digital Feedback Reducer will not enable you to increase system gain beyond the physical limits of the sound system. In most cases, you reach a point of diminishing returns after five to eight notch filters are set. This is because there are usually only a few dominant peaks in the response of the system. In most cases, you can expect a 6 dB to 9 dB improvement in gain-before-feedback by using the DFR. When you are ringing out the system and notice that many frequencies feedback simultaneously, you have reached the point of diminishing returns. If at this point the system still has insufficient gain before feedback, other changes must be made to the sound system, such as changing the placement of the microphones and/or loudspeakers.

There are two basic ways in which to set-up the DFR to reduce feedback; the Ring-Out Method and the Insurance Policy Method:

- Ring Out Method - With this method, you use the DFR as a preemptive measure against feedback for input channels that operate near the feedback point and need an extra margin of stability. Using this method, you raise the channel's gain beyond its normal setting to deliberately make the system feed back. The DFR will then set the proper filters. Then, when you reduce the input gain to an appropriate level, the system is stable and usable.
- Insurance Policy Method - With this method, you use the DFR as added insurance against unexpected feedback in an otherwise stable system. Simply place the DFR processor in the signal path, without defining any settings. This method is used for systems which already have sufficient gain-before-feedback, but need protection from occasional feedback occurrences due to non-stationary microphones or user-adjustable gain controls.

To ring out the system:

1. Remove any active filters by clicking the Clear All button.
2. Place microphones at their intended locations.
3. Set the mixer to Manual to open all mics.
4. Slowly raise the gain of the sound system while talking or clapping into the microphones.
5. Assign the DFR to the channel that begins to feed back. If multiple microphones feed back in the same frequency, assign the DFR to the mix bus.
6. The DFR processor will deploy notch filters to attenuate the feedback frequencies.
7. Once the system has stopped feeding back, you can continue by further raising the level and repeating the process for additional frequencies. Typically you can raise the gain 3 dB to 9 dB above the level at which feedback first occurred.
8. Lock the deployed filters so they are fixed. The remaining Unlocked (Dynamic) filters will deploy as needed when the system is in use. Note: Depending on the setup of the sounds system, the main PA signal may be separate from the monitor mix signal. Each feedback path should include a DFR for the maximum gain before feedback.

Assigning DFR

Two DFR blocks are assignable to any channel input or mix output. When using two or less microphones, assign the DFR to those channels to prevent feedback from routing to the mix bus. Additionally, if a microphone is designated for a chairperson or host, DFR should be applied to that channel to ensure that remains stable and does not feed back.

Apply DFR to a mix bus when using multiple non-stationary microphones or when trouble frequencies are feeding back simultaneously in multiple microphone channels.



Filter Types

By default, the DFR processor filters are unlocked to dynamically adjust as feedback frequencies are detected. However, you can specify how many of the total number of notch filters will remain fixed (locked). Use a greater number of locked (fixed) filters on input channels for stationary microphones. In this instance, the room acoustics define the dominant feedback frequencies, which do not change appreciably. Use a greater number of the dynamic (unlocked) filters on input channels for wireless or hand-held microphones. In this situation, feedback frequencies change drastically as the microphone user wanders the room or sound stage.

Both fixed and dynamic filters will automatically deepen as additional feedback is detected.

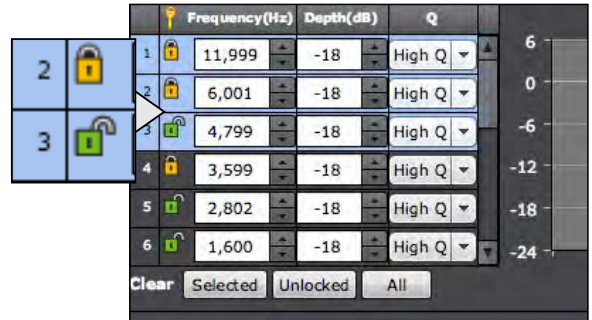

- **Locked (Fixed):** Once set, the frequency of a fixed filter will not change until it has been cleared or a new frequency manually entered.
- **Unlocked (Dynamic):** Frequencies are automatically assigned by the DFR as feedback is detected. Once a filter is deployed, it remains at that frequency until all filters are used. At that time, the DFR redeploys each dynamic filter at the newly detected frequency, in the order of oldest dynamic filter to newest.

Filter Width

The DFR offers two width options for notch filters. By default, filters in the DFR are deployed as High Q filters. As a high Q filter gets deeper its Q increases up to 101 (1/70th of an octave). You can also set filters to deploy at Low Q. Low Q filters affect a slightly wider range of frequencies by maintaining a Q of 58 (1/40th of an octave) as they deepen. To change the setting for an existing filter, select the Q-Width drop-down menu in the filter row.

New Filter Q: This setting determines the Q width for new Unlocked (Dynamic) frequencies as deployed by DFR.

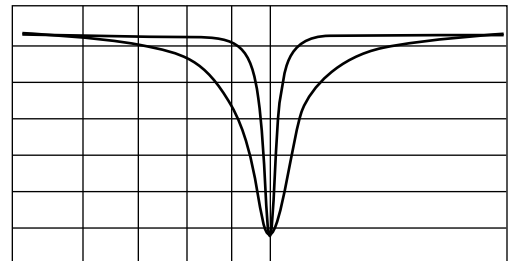

Navigation Bar



- 1) Tabs**
 The GUI is separated into six tabs that are used for different functions:

 - Input: Setup and management of input channels 1-8 and Aux
 - IntelliMix: Select Mix mode and load/save Customize IntelliMix settings
 - DFR: Set up and monitor Shure Digital Feedback Reducer (DFR) for up to two channels
 - Output: Assign the direct output and manage Mix A and Mix B outputs
 - Link Group: Manage the Link Group status of devices
 - Preferences: Configure network settings, set the device password, assign metering type, and engage hardware lockout.
- 2) Device List**
 Displays the name of the mixer as set in the Preferences tab. Click the drop-down bar and select a device to open its GUI in a new window or tab.
- 3) Identify**
 When clicked, this commands the mixer's LEDs to flash for easy identification.
- 4) Log Off**
 When a password is set, this button logs off of the device and returns the user to the Log On page. This button does not appear when there is no password (default).
- 5) Shure Web Link**
 Links to the Shure website at
- 6) Language**
 Sets the language of the GUI. This setting is saved to the computer's cookies.
- 7) Help**
 Opens the Help file for the GUI.

Input Tab

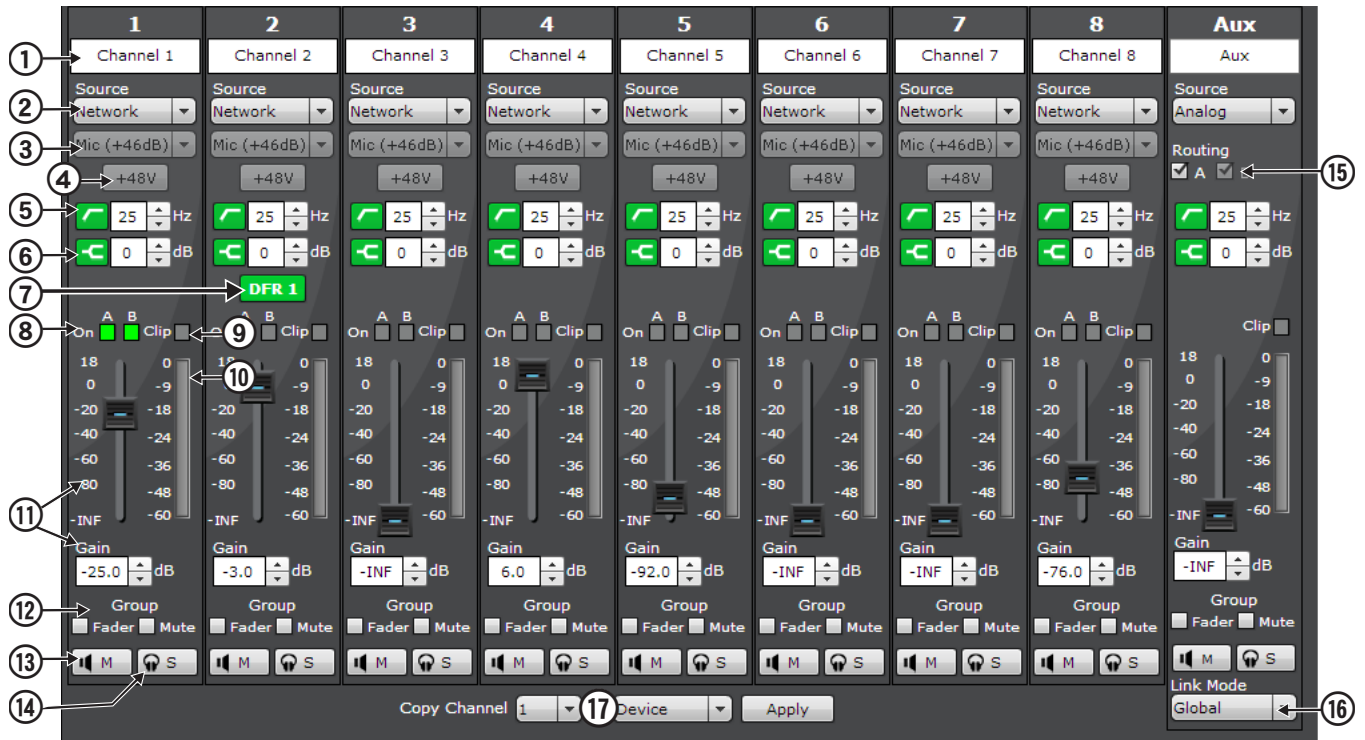

1) Channel Name

Channel names can be customized with up to 31 any characters in length except '=', ' ' or '@'.

2) Source

Sets the audio input to one of two sources:

- Analog (default): Audio is from a microphone or line-level audio source connected to a channel input on the mixer back panel.
- Network: Audio is from the Dante digital audio network. Dante Controller software is required to properly route audio to the channel inputs.

3) Input Gain Level

Selects the analog input gain level for each channel.

- Mic (+46 dB): For less sensitive microphones such as dynamics.
- Mic (+26 dB): For loud talkers or sensitive microphones such as condensers.
- Line (+0dB): For line-level sources such as mixer inserts.

Note: Gain is disabled when the audio source is set to Network.

4) Phantom Power (+48V)

When selected, the button illuminates green to indicate 48 V phantom power is supplied to the microphone. Use this setting for condenser microphones.

Note: Disabled when Input Gain Level is set to Line (+0dB) or Network is selected for the audio source.

5) Low Cut Button

Ideal for attenuating low-frequency vibration caused by table vibrations or air-conditioning rumble. Adjust the frequency of the 12 dB/octave filter from 25 - 320 Hz.

- Green= enabled
- Gray= disabled

6) High Shelf Button

For tempering sibilant speech or enhancing the sound of off-axis microphones. Use this to boost or cut the signal by 12 dB at 5 kHz.

- Green= enabled
- Gray= disabled

7) DFR Enable/Disable Button

When Digital Feedback Reducer (DFR) is assigned from the DFR tab, an enable/disable button appears in that channel strip.

- Green= enabled
- Gray= disabled

8) Channel On Indicators

The two indicators illuminate green when the channel is open to that mix bus (Mix A or Mix B). When set to Dual Mixer, the A and B indicators function separately for each mix.

9) Clip Indicator

Illuminates when the signal is clipping the input preamp. The light will stay lit as a warning for 2 seconds. Select a lower Input Gain Level to avoid clipping.

10) Input Meter

Displays signal level information. The meter is customizable in the Preferences tab to monitor the following options:

- Realtime monitoring of the input signal level (default) or IntelliMix Gain attenuation.
- Pre- or post-fader Input signal level.
- VU + Peak (default), Peak, or VU metering of input signal level_Ref86959235.

11) Channel Fader and Gain Value

Adjusts the channel volume from -110 dB to +18 dB.

12) Group (Fader and Mute)

Each channel can join a fader or mute group, which enable the adjustment of several channels at once. There is one Fader and one Mute group for each Link Group.

13) Mute Button

Mutes the audio for that channel. A muted channel still can still be soloed to the headphones for monitoring. Channel Mute Control can be set to one of two places from the IntelliMix tab:

- Pre-IntelliMix: Audio is muted before MaxBus or IntelliMix decisions.
- Post-IntelliMix: Audio is muted after contributing to IntelliMix and Maxbus decisions.

14) Solo Button

Solos the selected channel to the headphone jack for monitoring.

15) Aux Routing

Routes the aux channel to the selected mix output. The aux channel routes without automixing to the mix outputs.

16) Aux Link Mode

Defines the aux channel routing when the device is in a Link Group:

- Global (default): Aux audio appears at the outputs of all linked mixers.
- Local: Aux audio appears only at that mixer's output.

17) Copy Channel

Copies the selected channel's Input settings to the device or to the entire Link Group.



Mixer Settings

1) Mixer Type

The SCM820 can be set to operate as a single or dual mixer:

- **Single Mixer:** Channels are routed to a single mix bus that sends the same audio to both Mix A and B outputs. This allows the same program to be sent to different rooms or recording applications. The output gain, parametric equalizer and limiter can be set separately for each mix.
- **Dual Mixer:** Two separate buses provide independent automixes for each mix output. This allows two entirely different mixes to result from the same set of inputs or enables the SCM820 to function as two smaller independent mixers. This is useful when the mixer is being used for two applications. For example, set Mix A to Classic mode for sound reinforcement, and set Mix B to Smooth for a broadcast feed. As a dual mixer, each channel can route to Mix A, Mix B, both or neither mixes.

2) Mix Modes

The Mix Mode sets the IntelliMix configuration to determine the way the channels are mixed to the master outputs. When an adjustment is made to any IntelliMix preset, the mode automatically changes to Custom. See Mixer Modes section for configuration details of each preset. Press the mode button to highlight which channels are routed to that mix.

The color of the box around a channel correlates to the IntelliMix settings of the mix output. To view the other mix's settings, click on the mode for that mix.

Note: When set to Single Mixer operation, Mixes A and B are the same.

3) Save

Saves current Custom IntelliMix settings as a file to your computer.

4) Load

Uploads a saved Custom IntelliMix settings file.

Channel Strip

5) Channel Name

Displays the channel name as defined in the Inputs Tab.

6) Routing

Routes the channel to the Mix A or Mix B output. The routing options depend on the Mixer Type:

- **Single Mixer Type:** the channel can route to both or neither mixes.
- **Dual Mixer Type:** the channel can route to Mix A, Mix B, both, or neither mixes.

7) Gating Logic

When the mixer is set to Dual Mixer operation, this setting determines whether Mix A or Mix B controls the hardware functions (IntelliMix Direct Output), indicators (Channel Status LEDs) and channel Logic pins.

8) Always On

The Always On setting forces a channel to stay open continuously in the mix.

Note: A channel that is set to Always On still contributes to and is affected by the IntelliMix. For example, NOMA still applies to Always On channels.

9) NAT (Noise Adaptive Threshold)

Select to engage the NAT, which continuously adjusts the gate threshold for opening a channel. NAT is a core IntelliMix operating principle.

10) Offset

Sets the difference in dBs between the noise floor (determined by NAT) and a signal level, above which will open a channel.

11) Threshold

When NAT is deactivated, this manually determines the noise level above which a channel will gate open.

12) Chairperson

Override: When selected, it allows this channel to gate open regardless of NOM setting (number of open microphones).

Mute: When selected, all other channels mute when this channel gates open. There are two types of Chairperson Mute:

- **Auto:** Other channels automatically mute when the selected channel is gated open.
- **Manual:** A Logic-wired button connected to the Override In Logic pin controls the mute function applied to all other channels.

13) Gate Group

When any channel from the group is gated open, the rest of the group automatically gates open. There is one Gate Group for each Link Group. In Dual Mix mode, there is one gate group per Mix for each Link Group. This is disabled when the Gating Style is set to Relative.



14) Mute Control

Determines the location of a channel mute in the mixer's signal path.

- Pre-IntelliMix: the signal mutes prior to the Intellimix bus.
- Post-IntelliMix: the signal goes to the mix bus and is muted after it contributes to IntelliMix decisions (such as MaxBus and NOM).

Mix Outputs

15) Mix Name

Displays Mix Output name, set from the Mix Output tab.

16) Gating Style

Determines the way gain is applied to open channels.

- Full: Channels open at full gain, adjusted to the NOMA factor.
- Relative: Channels open at a gain level that varies with the input signal level—quieter signals receive less gain than loud signals. Note: Gate Group and Hold Time are disabled in this setting.

17) Gain Scaling

Determines how total system gain is managed. There are two types of Gain Scaling:

- Fixed: Off attenuation is a fixed amount. Total system gain varies with the number of open channels.
- Adaptive: Off attenuation is adjusted to maintain a uniform system gain comparable to that of a single open channel. Note: Off Attenuation, Last Mic Lock-On, and NOMA are disabled in this setting.

18) Off Attenuation

Sets the amount of attenuation applied to closed channels. This is disabled when the Gain Scaling is set to Adaptive.

19) Hold Time

In Full gating style, this determines how long a channel remains open after the signal level drops below the gate threshold. This is disabled when the Gating Style is set to Relative.

20) NOMA (Number of Open Microphone Attenuation)

NOMA attenuates the system gain as additional channels open in a mix. This controls system levels and reduces feedback. The parameter setting applies per doubling of microphones. This is disabled when the Gain Scaling is set to Adaptive.

21) MAX NOM (Number of Open Microphones)

Limits the maximum number of microphones that can be open in a mix at the same time. When set to Max, there is no limit.

Tip: Set the MAX NOM to 1 for "Filibuster Mode" (one talker at a time).

22) LMLO (Last Mic Lock On)

Avoids ambient dropout by keeping at least one channel open at all times (the last opened channel). This is disabled when the Gain Scaling is set to Adaptive.

23) Copy Channel

Copies the selected channel's IntelliMix settings to the device or to the entire Link Group.

Digital Feedback Reduction (DFR) Tab



1) Enable/Disable Button

Click this button to enable or disable the DFR notch filtering. It automatically turns on when DFR is assigned to a channel. When disabled, the DFR filters are turned off.

- Green= enabled
- Gray= disabled

2) Channel Assignment

Assign the DFR block to an input channel or mix bus.

3) # of Filters

Adjust the maximum number of filters from 1 to 16 (default).

4) Response Graph

This curve is a graphical representation of the processor's active notch filters (highlighted in yellow). The frequency of the currently selected filter is indicated by a red line.

5) Feedback Filters

Each filter row displays the filter type, frequency, depth and Q width. Between 1 and 16 filters are available for each DFR channel. When a row is selected, a red line appears on the response curve at that frequency.

6) Filter Type

This button designates the filter type so that its frequency either dynamically adjusts or remains fixed. In both types, DFR automatically adjusts the filter depth.

- Unlocked (Dynamic): the frequency is adjusted automatically
- Locked (Fixed): the frequency is fixed and will not change automatically

7) Frequency

This indicates the frequency of the selected filter. You can change the value by scrolling on the arrow buttons or by entering a specific value. The frequency range is from 25Hz to 20kHz. The value is blank (-----) until the filter is deployed by the DFR or entered manually.

8) Depth

This indicates the gain reduction of the selected filter. The range of available gain values is between 0 db and -18 dB in 0.5 dB increments, with a default setting of 0 dB.

9) Q-Width

This indicates the bandwidth type of the selected filter. Select High Q (default) or Low Q from the drop-down menu.

- High Q: 1/70th octave (Q=101)
- Low Q: 1/40 octave (Q=58)

10) New Filter Q

This selection designates the width of each new filter as it is deployed by DFR.

11) Freeze

Click this button to prevent both the deployment of new filters and the automatic adjustment of existing filters. Freeze the DFR to keep it from deploying filters for program material that contains sounds that closely resemble feedback (such as guitar effects, synthesized tones, flute or pipe organ). The button appears lighted in blue when the freeze feature is enabled. During this time, filters remain manually adjustable.

12) Auto Clear

This feature automatically clears Unlocked (Dynamic) filters and removes changes to the depth of Locked (Fixed) filters. Locked filter depth reverts to the level set when Auto Clear was enabled.

When enabled, Auto Clear occurs during each power cycle. Additionally, a repeating timeout can be defined to ensure that DFR filters clear regularly.

The Auto Clear timeout applies to each filter independently, and starts the moment it is deployed. The timer will restart after any change to a filter's frequency, depth, or Q. The timer has a range of 1 minute to 100 hours.

13) Clear Filter Buttons

- Selected: Clears settings for the selected filter(s).
- Unlocked: Clears settings for all Unlocked (Dynamic) filters.
- Clear All: Clears all settings in the DFR block and reverts all filters back to Unlocked (Dynamic).

14) Load/Save

All DFR parameters can be saved as a file to a computer and loaded to quickly recall settings. Note: DFR settings are included with SCM820 system settings that are saved from the Preferences tab.

15) Channel Fader and Gain Value

Channel gain is adjustable from the DFR tab for monitoring the notch filters when ringing out a sound system. Any adjustment made to the gain here is mirrored on the assigned channel strip.

Output Tab

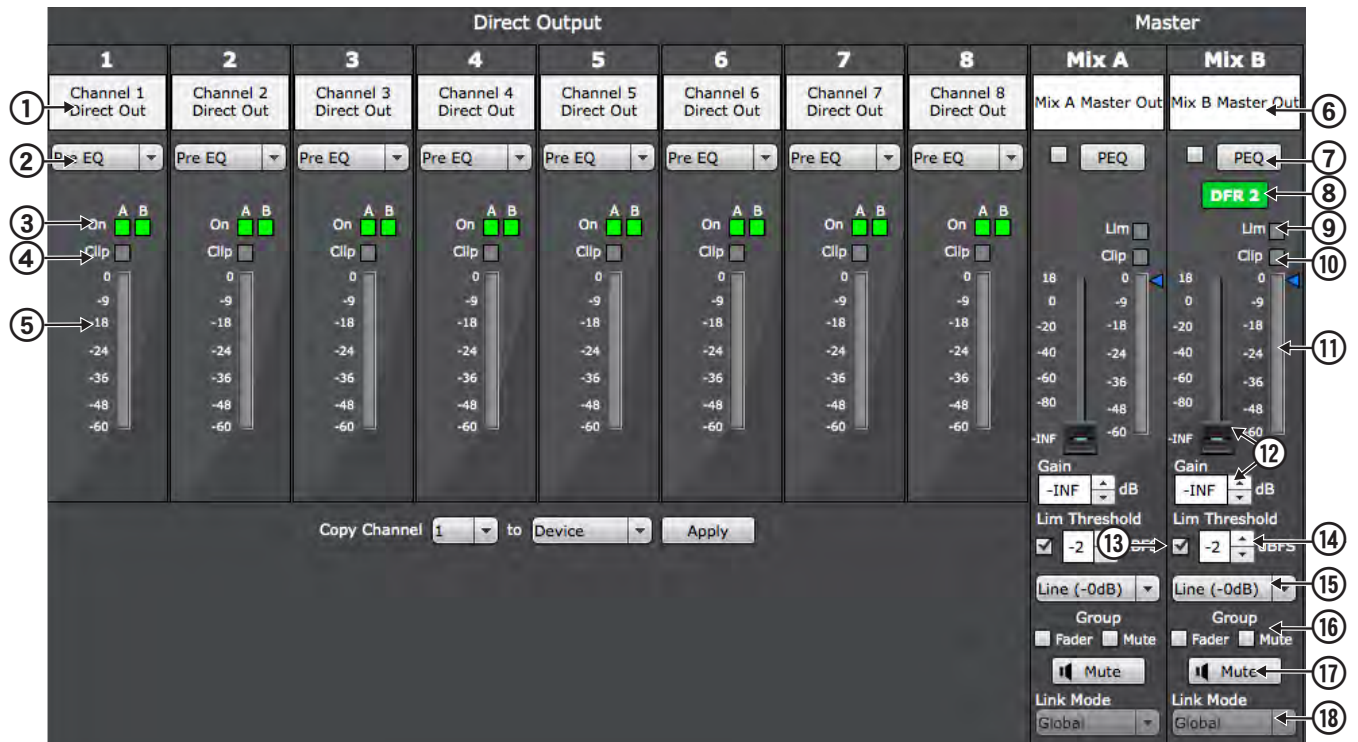

Direct Output

1) Channel Name

Displays the channel name as defined in the Inputs Tab.

2) Direct Output Selection

The direct output can be routed from one of five stages in the signal path:

- Pre-EQ (default): After the Input Gain
- Post-EQ: After the EQ blocks
- Post-Fader: After the channel fader
- IntelliMix: After the IntelliMix gating decision
- IntelliMix NOMA: After IntelliMix gating and after NOMA is applied

3) Direct Output On Indicator

The two indicators the gating states that are used for the direct outputs.

4) Clip Indicator

Illuminates when the input signal overloads the digital-to-analog converter. The light will stay lit as a warning for 2 seconds.

5) Direct Output Meter

Displays the channel's direct output signal level.

Master

6) Mix Output Name

Mix names can be customized with up to 31 any characters in length except '=', ',', or '@'.

7) PEQ (Parametric Equalizer)

Each mix output has an 8-band parametric EQ that is engaged by the check box. Press the button to open the PEQ window.

8 bands are editable from the PEQ, including a low and high shelf. Select the box to engage the band and edit the following parameter:

- Frequency: Sets the center frequency for each band from 25 - 20,000 Hz.
- Width and Q: This setting adjusts the bandwidth of the EQ adjustment from very narrow (1/70 octave or 100.99Q) to very wide (4 octaves or 0.27 Q).
- Gain: Sets boost or cut of the EQ setting from -18 to +18 dB.

8) DFR Enable/Disable Button

When DFR is assigned from the DFR tab, an enable/disable button appears in that channel strip.

- Green= enabled
- Gray= disabled

9) Lim (Limiter) Indicator

Illuminates to indicate that the signal has exceeded the limiter threshold, engaging the limiter.

10) Clip Indicator

Illuminates when the signal has clipped the outputs, holding for two seconds.

11) Output Meter

Displays the output signal level.

12) Fader and Gain Value Box

Adjusts the mix volume from -110 dB to +18 dB.

13) Limiter Activation Box

Activates the limiter when selected.

14) Limiter Threshold

Set the limiter threshold from -2 to -50 dBFS for the mix outputs. The level is indicated by the blue triangle next to the meter.

15) Output Level

Selects the output level of the mix outputs. Set according to the input of the connecting equipment. There are three settings: Line (-0dB) (default), Aux (-20dB), Mic (-46dB).

16) Group (Fader or Mute)

Adds the mix to the Fader or Mute group. Groups allow the adjustment of several mixes outputs at once. There is one Fader and one Mute group per Link Group.

17) Mute

Mutes the audio output for that mix.

18) Link Mode

Defines the audio content for the mix outputs when the device is in a Link Group.

- Global (default): The mixer's outputs contain audio from the entire Link Group.
- Local: The mixer's outputs contains only the audio from that mixer's inputs.

Link Group Tab

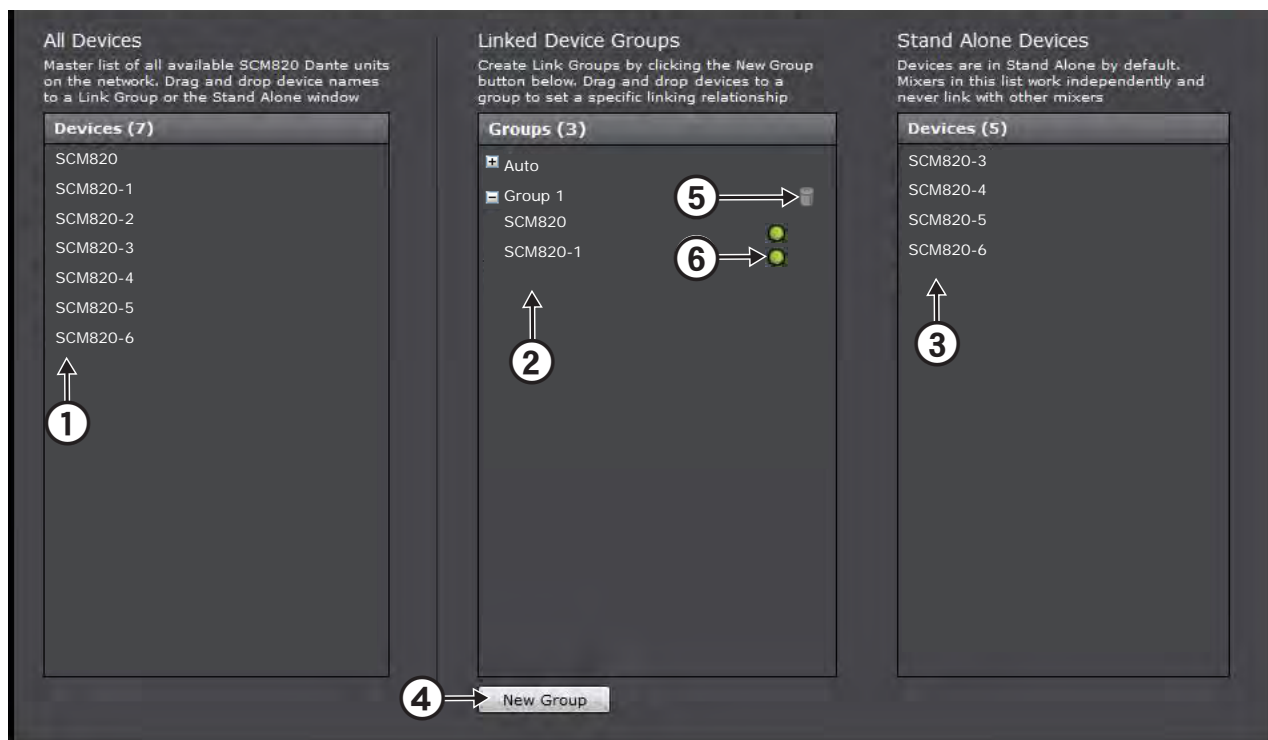

1) All Devices List

- Master list of all available SCM820 Dante units on the network.
- Drag and drop the devices to a Link Group or the Stand Alone Window.
 - Select a device to view its location in either the Linked or Stand Alone device windows.

2) Linked Device Groups

Displays each Link Group along with the number of devices that comprise it. There is one Auto group that includes up to 12 mixers that have Auto Link enabled.

When a device is placed in a group, it will automatically configure the unit to the group's settings.

3) Stand Alone Devices List

Displays all mixers that function independently of a link group.

4) New Group Button

Creates a new Link Group to the list.

5) Delete Group Button

Deletes an empty group from the Linked Device Group window. This is inactive if there are any mixers in the group.

6) Link Status Indicator

- Green: Link group is ready.
- Flashing Green: Link group is configuring.

Preferences Tab

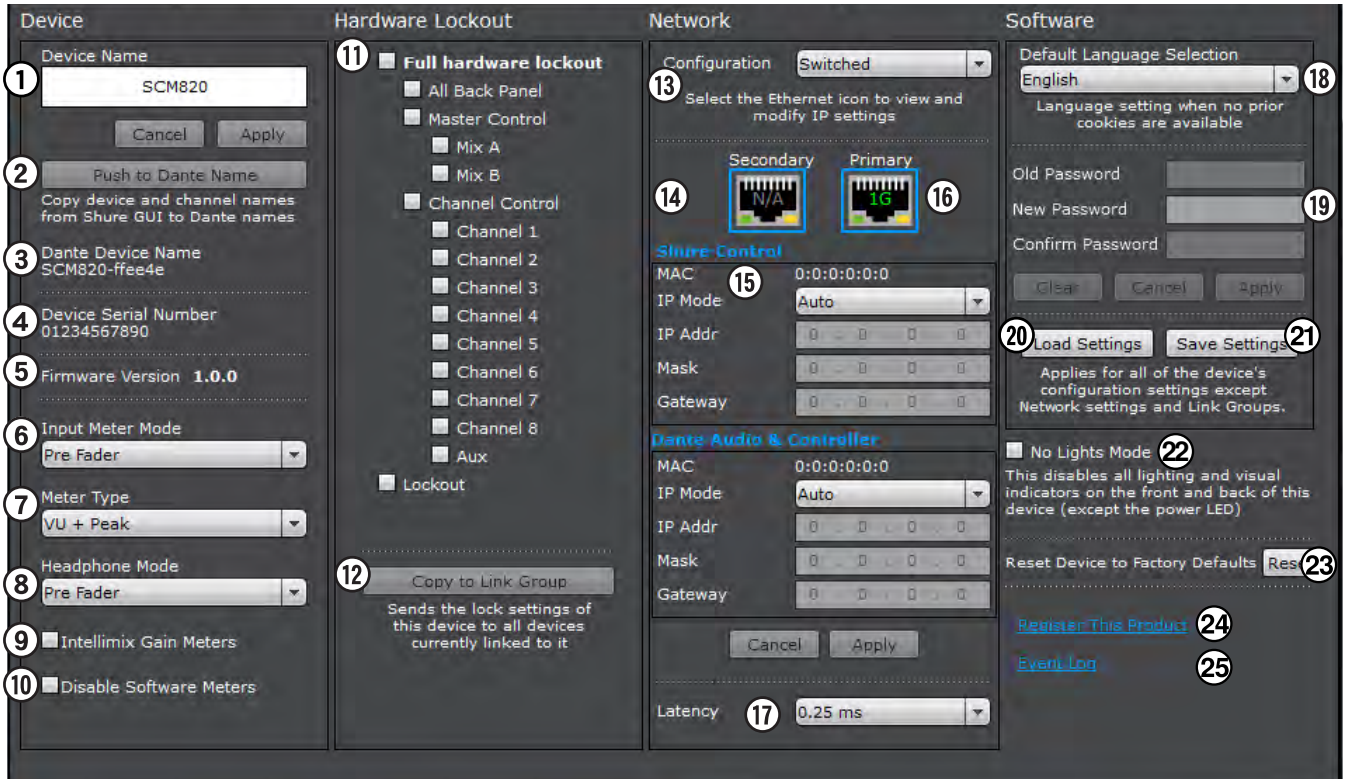

Device

1) Device Name

Device names can be customized with up to 31 any characters in length except '=',', or '@'.

2) Push to Dante Name

Overwrites the device and channel names in Dante Controller (DC) software. Note: Use with caution, as this could break the routing configuration in DC and cause audio interruptions.

3) Dante Device Name

The name of the device in Dante Controller.

5) Firmware

Displays the firmware version of the device.

6) Input Meter Mode

Determines if the channel meters are before (Pre-Fader) or after (Post-Fader) the channel's volume knob/fader.

7) Meter Type

Selects the information displayed on the channel input meters on the Input tab:

- VU+Peak (default): Peaks display as a hash bar; average signal levels are displayed as a solid bar.
- VU: Displays average audio signals.
- Peak: Displays peak audio signals with a peak hold displayed as a hash bar.

8) Headphone Mode

Routes audio to the headphone output from one of two stages in the signal path:

- Pre Fader (default): Post EQ and pre-volume knob/fader.
- Post-Fader: Post EQ and post-volume knob/fader. This is post-limiter for the mix adjustments.

9) IntelliMix Metering

Changes the GUI Input meters to display IntelliMix attenuation applied in realtime, as displayed with an orange meter. Channels that gate open will display more gain than channels that are closed (attenuated) in the mix.

10) Disable Software Meters

When selected, this turns off all metering in the GUI. Disabling meters helps to reduce network traffic. (This does not affect the hardware metering.)

Hardware Lockout

11) Hardware Lockout

Disables hardware controls on the mixer. This can lockout the entire mixer or specific functions: all back panel, master controls, channel controls, and the lockout button on the mixer back panel.

12) Copy to Link Group

Copies Hardware Lockout settings to the entire Link group

Network

13) Configuration

Determines the routing of Shure Control and Dante Audio & Controller data from the two network ports. See Port Configuration for details. Follow these steps to change the Configuration mode:

1. Disconnect the mixer from the network.
2. Connect the Primary port of the mixer directly to a computer.
3. Go to the Network panel in the GUI: Preferences > Network
4. Select the Configuration mode. The mixer will reboot once the selection is confirmed.
5. Repeat for each mixer.

Warning: Do not reconnect mixers to the network until the network settings are the same for all units.

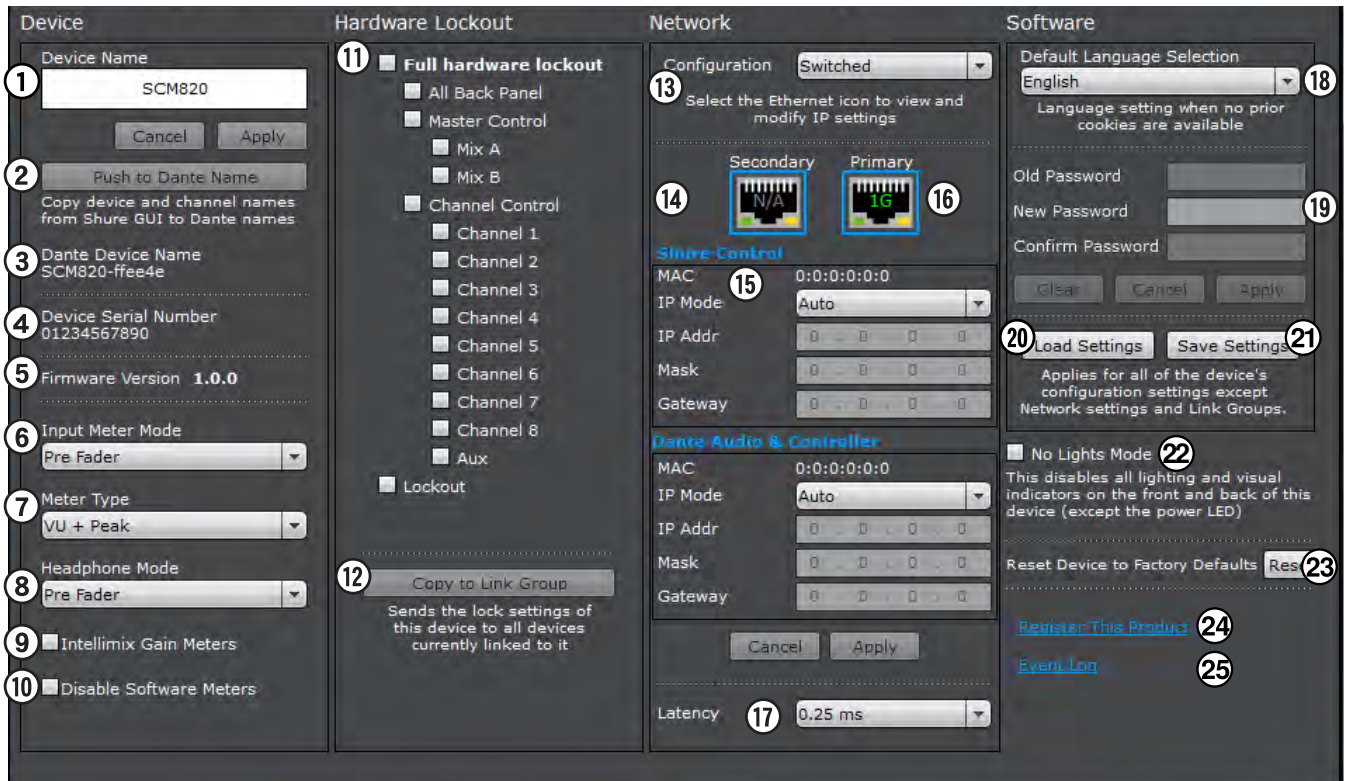

14) Interface

Click to view audio and control data routing for each interface.

15) IP Settings

Displays the network settings for each port:

- Auto: For automatic DHCP or Link-Local IP addresses
- Manual: For Static IP addresses

16) Network Speed

Indicates the speed of the network.

17) Dante Latency

The latency setting for Dante devices should be set according to the number of switches in the network. The SCM820 network card has an internal switch chip and counts as a switch. For example, one SCM820 connected to an external switch equals two switches.

See Latency section for more details.

Software

18) Default Language Selection

Determines the language of the GUI when it opens on a computer with no prior cookies.

19) Password

By default, no password is required to log on to the GUI. To add an Administrator password for the GUI, follow these steps:

1. Enter password into the New Password field
2. Repeat for the Password (Confirm)
3. Select Apply to set the password.

Once a password is set, any user can log on as a Guest to view the GUI without changing settings.

To clear a password and allow anyone full editing rights:

1. Log on to the GUI
2. Enter the current password into the Old Password text field.
3. Press the Clear button.

20) Load Settings Button

Uploads a file of saved settings to the device. This reconfigures the IntelliMix settings of all units in a Link Group.

21) Save Settings Button

Select the Save Settings button to save the mixer settings (configuration of the Input, IntelliMix, Output and Preferences tabs). Note: Link Group and IP settings are not saved.

22) No Lights Mode

Turns off all visual indicators on the mixer (except the Power LED on the front panel).

23) Reset

Returns the mixer to default factory settings (clearing the password and device and channel names). The mixer will reboot in Standalone mode.

24) Register This Product

Links to Shure website for product registration.

25) Event Log Link

Links to the device's Event Log, which opens in a new browser tab or window. The log displays a list of all informational system events.

Log On Page

This page is only displayed after a password has been set from the Preferences tab, establishing an Administrator log in. When there is no Administrator, there are no restrictions changing a device's settings.

Note: No more than five Administrators or Guests should be logged on to a device's GUI at the same time. Opening more instances may degrade system performance.

1) User

When a password is set, there are two levels of access for the GUI:

- Admin: Full editing rights.
- Guest: User can only monitor (cannot change settings).

2) Password

Required for Admin access. The password can be set or cleared on the Preferences tab.

3) Keep Me Logged On

When selected, this allows the user to bypass the Log On page when re-opening the GUI.

4) Language

Sets the language of the GUI. This setting is saved to the computer's cookies.



Event Log

The event log provides a detailed account of mixer activity from the moment the mixer is powered on. The log collects and time-stamps up to 1,000 activity entries for the mixer. The Event Log is a reference tool for troubleshooting when calling Shure Systems Support or Service Department.

The log categorizes entries into Events, Warnings and Errors:

- Events: An action has been successfully completed.
- Warnings: An action can not be completed, though overall mixer functionality is stable.
- Errors: Catastrophic problem has occurred that inhibits the mixer's functionality. This corresponds to the 8-bit error codes that flash on the front-panel LEDs.

Viewing the Event Log

1. Open the Preferences tab of the GUI.
2. Select the Event Logs link from the Preferences panel. The log is located with the device's DNS name: <device URL>/logs.

TIME DAY:HR:MIN:SEC	EVENT
0000:00:52:41	151 Dante Mute
0000:00:52:36	151 Dante Mute
0000:00:00:16	q_t=3171 Start UnMute
0000:00:00:16	q_t=930 Link Reconfig Position 0
0000:00:00:16	q_HeapAddr=e0db4
0000:00:00:16	q_t=826 Done Muting
0000:00:00:16	t=q_825 Start Muting
0000:00:00:16	q_t=1 Dsp Booted
0000:00:09:30	151 Dante Mute
0000:00:00:16	q_t=3161 Start UnMute
0000:00:00:16	q_t=929 Link Reconfig Position 0
0000:00:00:16	q_HeapAddr=e0db4
0000:00:00:16	q_t=826 Done Muting
0000:00:00:16	t=q_825 Start Muting
0000:00:00:16	q_t=1 Dsp Booted
0000:00:00:16	q_t=3199 Start UnMute
0000:00:00:16	q_t=959 Link Reconfig Position 0
0000:00:00:16	q_HeapAddr=e0db4

Total Number Of Events: 1000

Troubleshooting

Audio

Problem	Indicator	Solution
Distorted audio	Channel Status LED = Flashing Red	• Set Analog Input to a lower level
	Mix Output meter = Clipping	• Turn down master gain
No Audio/Faint Audio	Channel LEDs in Channel Meter mode (front panel) = Off	• Check cables • Enable Phantom power for condenser microphones • Check Input Gain Level
	Mix Output meters = Off	• Ensure mix is unmuted • Turn up Master volume knob • Check channel routing from IntelliMix tab of the GUI • Check Link Group and Network LEDs (see Link Groups).

Network

Problem	Indicator	Solution
Can't Connect to the GUI	Device not appearing in Shure Web Device Discovery application	• Ensure the mixer is powered • Properly connect the Primary port to the computer's network • Turn off other network interfaces not used to connect to the mixer (including WiFi) • Check that DHCP server is functioning (if applicable) • Ensure Bonjour is running on the PC
	Device appears in Shure Discovery application, but web browser cannot connect to the device	• Download latest version of Adobe Flash • Ensure PC and mixer are on the same subnet
GUI is taking a long time to load	Browser opens but the GUI is slow to load	• Set the computer gateway to 0.0.0.0 • Set the router to not send default gateway as a part of DHCP • Manually set the computer to a static IP address on the same network as the mixer
GUI is slow	Indicators are moving slowly or not displaying in real time.	• Ensure that five or less windows are open to the same GUI • Disable software meters from GUI Preferences tab • See Network section for properly setting up the network

Network Audio and Link Groups

Problem	Indicator	Solution	
Network audio is missing or distorted	Network Audio LED	Green	• Check channel and mix gain
		Flashing Green	• Ensure the mixer has a stable network connection • Use Dante Controller software (DC) to verify channel subscriptions
		Red	• Check master clock in DC
		Off	• Use DC to properly route audio channels
No audio output for mixers in a Link Group	AutoMix Link LED	Green	• Turn up master gain control • Check Global/Local setting for the Mix Outputs
		Flashing Green	• Wait until the group has reconfigured
		Off	• Ensure the mixer has been assigned to a Link Group from the Link Group tab of the GUI

Hardware

Problem	Indicator	Solution
Can't make adjustments to the mixer	lockout LED = Red	• Press and hold lockout button on the back panel for 5 seconds to disable the lockout. • If the mixer is still locked, open the GUI and uncheck the Hardware Lockout button in the Preferences tab.
No LEDs are turning on	Power button = On	• Uncheck No Lights Mode from the GUI Preferences tab

Event Log

The event log provides a detailed account of mixer activity from the moment the mixer is powered on. The log collects up to 1,000 activity entries for the mixer, and time-stamps them relative to the last power cycle.

To troubleshoot audio or hardware problems, press Save Log to export to a computer file. Refer to the log file for details when troubleshooting or consulting with Shure Systems Support.

The log categorizes entries into Events, Warnings and Errors:

- **Events:** An action has been successfully completed.
- **Warnings:** An action can not be completed, though overall mixer functionality is stable.
- **Errors:** A problem has occurred that could inhibit the mixer's functionality. This corresponds to error messages that flash on the front-panel LEDs.

Viewing the Event Log

To view the event log:

1. Open the Preferences tab of the GUI.
2. Select the Event Log hyperlink on the bottom left of the Preferences panel. The log is located with the device's DNS name: **<device URL>/eventlog/**.

Front-Panel Error Messages

An error message is generated on the Channel LED rings when operating or environmental conditions occur that could potentially harm the mixer. These types of messages indicate the mixer has experienced a critical failure. Before calling Shure System Support, try these basic debugging tools:

1. Open the Event Log and press Save Log to export the file to your computer.
2. Power cycle the device by switching the power button off and on again.
3. Reset the device to factory default settings. This will clear all configurations made to the mixer.
5. If the error message persists, contact a Shure support representative for your region.

Note: To temporarily clear an error message until troubleshooting can be conducted, simultaneously press the Channel 1 knob and Front Panel Mode selector.

Device Overheating Message

One example of an error message is the Device Overheating message. This appears on the channel LEDs in the following pattern as illustrated in the drawing. For this message, it is recommended that the device be immediately cooled down to avoid permanent damage. If the problem persists, follow the steps listed above to try to clear the message.

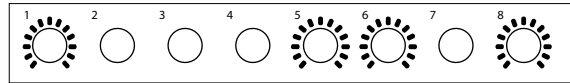

Device Overheating Error Code

Specifications

Audio Frequency Response

20 Hz to 20 kHz (± 1 dB)

Dynamic Range

20 Hz to 20 kHz, A-weighted, typical

Analog-to-Analog	110 dB
Analog-to-Dante, Dante-to-Analog	113 dB

Output Noise (mix output / direct output)

20 Hz to 20 kHz, A-Weighted, one channel open

Output Pad		
Line (-0dB)	Aux (-20dB)	Mic (-46dB)
-90 dBV	-110 dBV	-135 dBV

Equivalent Input Noise

20 Hz to 20 kHz, A-Weighted, input terminated with 150 Ω , digital gain at +18 dB

Input Gain Setting		
Line (+0dB)	Mic (+26dB)	Mic (+46dB)
-93 dBV	-118 dBV	-130 dBV

THD+N

1 kHz, +4 dBu out, mix output (MASTER) at +0 dB
<0.05%

Common Mode Rejection Ratio

150 Ω balanced source, at 1kHz
>70 dB

Polarity

Non-inverting, any input to any output

Dimensions

44 mm x 483 mm x 289 mm (1.7 in. x 19.0 in. x 11.4 in.), H x W x D

Weight

5.5 kg (12.0 lbs)

Housing

Steel; Extruded aluminum

Power Requirements

100 to 240 V AC, 50-60 Hz, 1 A

Operating Temperature Range

-18°C (0°F) to 63°C (145°F)

Storage Temperature Range

-29°C (-20°F) to 74°C (165°F)

Analog Connections

Channel Input

Configuration	Impedance	Clipping Level		
		Line (+0dB)	Mic (+26dB)	Mic (+46dB)
Active Balanced	5 k Ω	+20 dBV	-6 dBV	-26 dBV

Phantom Power

48 V DC, selectable per channel, 14 mA max.

Mic level settings only. Phantom power automatically switched off in LINE position.

Aux Input

Configuration	Impedance	Clipping Level
stereo, unbalanced	10 k Ω	+10 dBV

Mix Output

Configuration	Impedance	Max Output Level		
		Line (-0dB)	Aux (-20dB)	Mic (-46dB)
Active Balanced	350 Ω	+20 dBV	0 dBV	-26 dBV

Direct Output

Configuration	Impedance	Max Output Level
Impedance Balanced	150 Ω	+20 dBV

Headphone Output

6.35 mm (1/4") TRS, 100 mW, 350 Ω , dual mono (will drive stereo phones)

Digital Signal Processing

AD/DA Converter

24-bit, 48 kHz, 113 dB dynamic range typical

Internal Processing

32-bit

Latency

From channel input to mix output, Estimated Nominal, ± 0.1 ms

	Single Device (ms)	In a Link Group (ms)
Analog to Analog	0.51	$0.76 + 4T_N$
Analog to Dante	0.29	$0.54 + 4T_N$
Dante to Analog	$0.28 + T_N$	$0.53 + 5T_N$
Dante to Dante	$0.06 + T_N$	$0.31 + 5T_N$

T_N = Network latency in milliseconds, as set in the device preferences page or Dante Controller.

Note: Dante network latency is typically associated with the receiving device.

Channel Input Processing

Gain Adjustment Range	-110 dB to +18 dB
Low Cut	Corner: 25 Hz to 320 Hz Slope: 12dB/octave
High Shelf	Corner: 5 kHz Slope: 12dB/octave Gain: -18 dB to +18 dB

Mix Output Processing

Gain Adjustment Range	-110 dB to +18 dB
Low Shelf	Corner: 25 Hz to 20 kHz Slope: 12dB/octave Gain: -18 dB to +18 dB
High Shelf	Corner: 25 Hz to 20 kHz Slope: 12dB/octave Gain: -18 dB to +18 dB
6-Band PEQ	25 Hz to 20 kHz, ± 18 dB Bandwidth: 1/70 to 4 octaves
Limiter	Ratio: 10:1 Threshold: -50dBFS to -2dBFS Attack: 0.1 ms Decay: 100 ms

Digital Feedback Reducer (DFR) Processing

Number of DFR Blocks	2
Number of Notch Filters	1 to 16 (default)
Notch Filter Bandwidth	High Q: 1/70th octave (Q=101) Low Q: 1/40th octave (Q=58)
Notch Filter Depth	0 db to -18 dB in 0.5 dB increments

Networking

Network Interface

SCM820	Single Port, 10/100 Mbps Ethernet
SCM820-DAN	Dual Port, Gigabit Ethernet, Dante digital audio

Cable Requirements

Cat 5e or higher, shielded, 100 m maximum

Network Addressing Capability

DHCP, link-local, static

IP Ports and Protocols

Shure Control

Port	TCP/UDP	Protocol	Description	Factory Default
21	tcp	FTP	Required for firmware updates (otherwise closed)	Closed
22	tcp	SSH	Not supported	Closed
23	tcp	Telnet	Standard console interface	Closed
68	udp	DHCP	Dynamic Host Configuration Protocol	Open
80*	tcp	HTTP	Required to launch embedded web server	Open
427	tcp/udp	SLP	Required for inter-device communication	Open
443	tcp	HTTPS	Not supported	Closed
161	tcp	SNMP	Not supported	Closed
162	tcp	SNMP	Not supported	Closed
843*	tcp	Flash	Required for web GUI	Open
2202	tcp	ASCII	Required for 3rd party control strings	Open
5353	udp	mDNS	Required for device discovery	Open
5568	udp	SDT	Required for inter-device communication	Open
8023	tcp	Telnet	Debug console interface	Password
8180*	tcp	Flash	Required for web GUI	Open
8181*	tcp	Flash	Required for web GUI	Open
8427	udp	Multicast SLP	Required for inter-device communication	Open
64000	tcp	Telnet	Required for Shure firmware update	Open

Dante Audio & Controller

Port	TCP/UDP	Protocol	Description
162	udp	SNMP	Used by Dante
[319-320]*	udp	PTP	Dante clocking
4321, 14336-14600	udp	Dante	Dante audio
[4440, 4444, 4455]*	udp	Dante	Dante audio routing
5353	udp	mDNS	Used by Dante
[8700-8706, 8800]*	udp	Dante	Dante Control and Monitoring
8751	udp	Dante	Dante Controller
16000-65536	udp	Dante	Used by Dante

*These ports must be open on the PC or control system to access the device through a firewall

Connector Diagrams

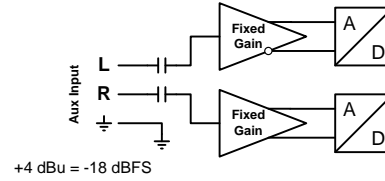
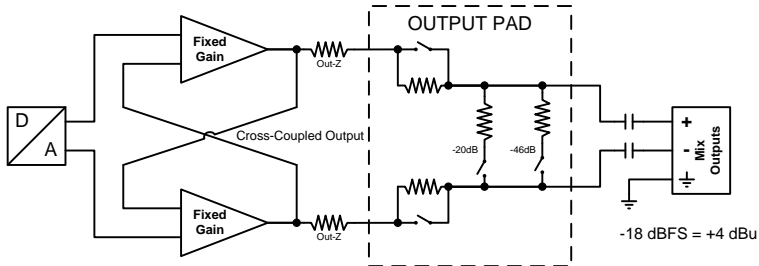
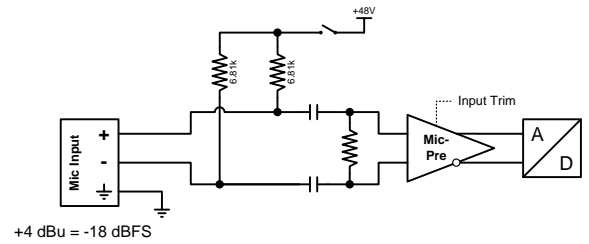
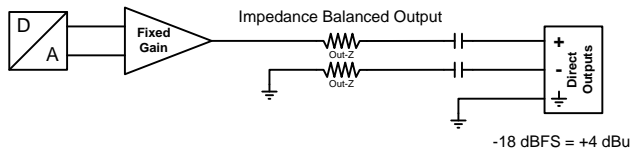

Pinouts are from the perspective of looking at the back of the unit

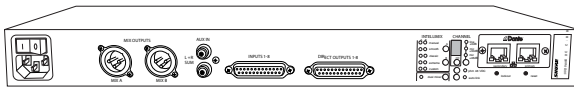

- 1 = Ground
- 2 = Positive
- 3 = Negative

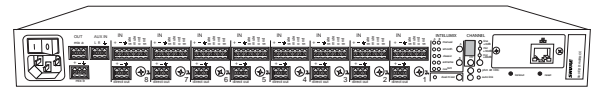

Channel Inputs and Direct Outputs

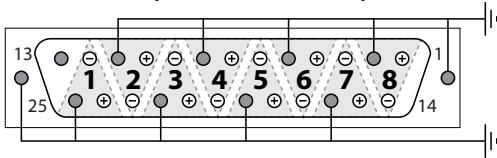

Inputs

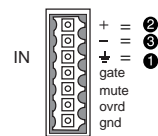

Direct and Mix Outputs

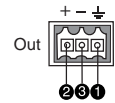

Aux Input

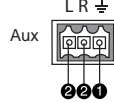

Mix Outputs



Aux Input

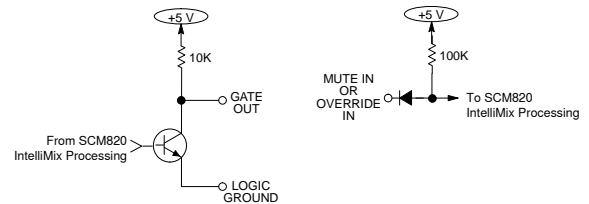
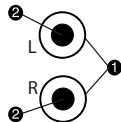

SHURE[®]