



User's Manual

event series



Antes de utilizar el equipo, lea la sección "Precauciones de seguridad" de este manual. Conserve este manual para futuras consultas.

Before operating the device, please read the "Safety precautions" section of this manual. Retain this manual for future reference.

CONTENTS

SAFETY PRECAUTIONS	3
WARRANTY	4
DECLARATION OF CONFORMITY	5
INTRODUCTION	6
CONFIGURATIONS	7 a 10
8 <i>event 208A</i> + 4 <i>event 218A</i>	
12 <i>event 208A</i> + 6 <i>event 218A</i>	
16 <i>event 210A</i> + 8 <i>event 218A</i>	
24 <i>event 210A</i> + 12 <i>event 218A</i>	
SPECIFICATIONS	11
LINE DRAWINGS	12
AMPLIFIER	13 a 15
Description	
ON / OFF	
Overload indicator	
Equalisation	
Overheating	
Low mains voltage	
Current consumption	
Troubleshooting	
RIGGING SYSTEM	16 a 17
APPENDIX I	18
<u>Line connections: unbalanced and balanced</u>	



Cajas acústicas activas / Self-powered loudspeaker enclosures

El signo de exclamación dentro de un triángulo indica la existencia de importantes instrucciones de operación y mantenimiento en la documentación que acompaña al producto. Conserve y lea todas estas instrucciones. Siga las advertencias. **ATENCIÓN:** Es un producto clase A, por lo que en entornos domésticos puede causar radio-interferencias, en cuyo caso el usuario tendrá que tomar las medidas oportunas. De acuerdo con EN55103-2, usar el equipo sólo en entornos E1, E2, E3 ó E4.



The exclamation point inside an equilateral triangle is intended to alert the users to the presence of important operating and maintenance (servicing) instructions in the literature accompanying the product.

Heed all warnings. Follow all instructions. Keep these instructions.

WARNING: This is a class A product. In a domestic environment this product may cause radio interferences in which case the user may be required to take adequate measures.

Use this product only in E1, E2, E3 or E4 environments according to EN55103-2.

Do not remove mains connector ground, it is dangerous and illegal. Class I device.

No desconecte la tierra en el conector de alimentación pues el peligroso e ilegal. Equipo de Clase I.

El signo del rayo con la punta de flecha, alerta contra la presencia de voltajes peligrosos no aislados. Para reducir el riesgo de choque eléctrico, no retire la cubierta. Sólo use este equipo con el cable de red de alimentación adecuado para su país.



The lightning and arrowhead symbol warns about the presence of uninsulated dangerous voltage. To reduce the risk of electric shock, do not remove the cover.

Only use this equipment with an appropriate mains cord for your country.

Do not install near any heat sources such as radiators, heat registers, stoves or other apparatus that produce heat.

The circulation of air through the heatsink must not be blocked.

No instale el aparato cerca de ninguna fuente de calor como radiadores, estufas u otros aparatos que produzcan calor. Debe instalarse siempre sin bloquear la libre circulación de aire por las aletas del radiador.

No exponga este equipo a la lluvia o humedad sin el protector de lluvia recomendado. No exponga el equipo a salpicaduras sin el protector de lluvia recomendado, ni coloque sobre él objetos que contengan líquidos, tales como vasos y botellas.

Do not expose this device to rain or moisture without the rain protector supplied. Do not place any objects containing liquids, such as bottles or glasses, on the top of the unit. Do not splash liquids on the unit without the rain protector supplied.

Este símbolo indica que el presente producto no puede ser tratado como residuo doméstico normal, sino que debe entregarse en el correspondiente punto de recogida de equipos eléctricos y electrónicos.



This symbol on the product indicates that this product should not be treated as household waste. Instead it shall be handed over to the applicable collection point for the recycling of electrical and electronic equipment.

Equipo diseñado para funcionar entre 15°C y 45°C con una humedad relativa máxima del 95%, con un rango de $\pm 10\%$ de la tensión nominal de alimentación indicada en la etiqueta trasera (según IEC 60065:2001). Si debe sustituir el fusible preste atención al tipo y rango.

Working temperature ranges from 15°C to 45°C with a relative humidity of 95%, with $\pm 10\%$ of the rated main voltage value indicated on the rear label (according to IEC 60065:2001). If the fuse needs to be replaced, please pay attention to correct type and ratings.

El cableado exterior conectado al equipo requiere de su instalación por una persona instruida o el uso de cables flexibles ya preparados.

The outer wiring connected to the device requires installation by an instructed person or the use of a flexible cable already prepared.

Si el aparato es conectado permanentemente, la instalación eléctrica del edificio debe incorporar un interruptor multipolar con separación de contacto de al menos 3mm en cada polo.

If the apparatus is connected permanently, the electrical system of the building must incorporate a multipolar switch with a separation of contact of at least 3mm in each pole.

Desconecte este aparato durante tormentas eléctricas, terremotos o cuando no se vaya a emplear durante largos periodos.

Unplug this apparatus during lightning storms, earthquakes or when unused for long periods of time.

No emplace altavoces en proximidad a equipos sensibles a campos magnéticos, tales como monitores de televisión o material magnético de almacenamiento de datos.



Do not place loudspeakers in proximity to devices sensitive to magnetic fields such as television monitors or data storage magnetic material.

El colgado del equipo sólo debe realizarse utilizando los herrajes de colgado recomendados y por personal cualificado. No cuelgue la caja de las asas y respete los valores máximos de carga dados en el manual.

The appliance should be flown only from the rigging points and by qualified personnel. Do not suspend the box from the handles and respect the maximum load values given in the manual.

No existen partes ajustables por el usuario en el interior de este equipo. Cualquier operación de mantenimiento o reparación debe ser realizada por personal cualificado. Es necesario el servicio técnico cuando el equipo se haya dañado de alguna forma, como que haya caído líquido o algún objeto en el interior del aparato, haya sido expuesto a lluvia o humedad, no funcione correctamente, haya recibido un golpe o su cable de red esté dañado.

No user serviceable parts inside. Refer all servicing to qualified service personnel. Servicing is required when the apparatus has been damaged in any way, such as power-supply cord or plug is damaged, liquid has been spilled or objects have fallen into the apparatus, the apparatus has been exposed to rain or moisture, does not operate normally or has been dropped.

Limpie con un paño seco. No use limpiadores con disolventes.

Clean only with a dry cloth. Do not use any solvent based cleaners.

GARANTÍA

Todos nuestros productos están garantizados por un periodo de 24 meses desde la fecha de compra.

Las garantías sólo serán válidas si son por un defecto de fabricación y en ningún caso por un uso incorrecto del producto.

Las reparaciones en garantía pueden ser realizadas, exclusivamente, por el fabricante o el servicio de asistencia técnica autorizado.

Otros cargos como portes y seguros, son a cargo del comprador en todos los casos.

Para solicitar reparación en garantía es imprescindible que el producto no haya sido previamente manipulado e incluir una fotocopia de la factura de compra.

WARRANTY

All D.A.S. products are warrantied against any manufacturing defect for a period of 2 years from date of purchase.

The warranty excludes damage from incorrect use of the product.

All warranty repairs must be exclusively undertaken by the factory or any of its authorised service centers.

To claim a warranty repair, do not open or intend to repair the product.

Return the damaged unit, at shippers risk and freight prepaid, to the nearest service center with a copy of the purchase invoice.



DECLARACIÓN DE CONFORMIDAD DECLARATION OF CONFORMITY

D.A.S. Audio, S.A.

C/ Islas Baleares, 24 - 46988 - Pol. Fuente del Jarro - Valencia. España (Spain).

Declara que la serie **event**:

Declares that **event** series:

Cumple con los objetivos esenciales de las Directivas:

Abide by essential objectives relating Directives:

- Directiva de Baja Tensión (Low Voltage Directive) 2006/95/CE
- Directiva de Compatibilidad Electromagnética (EMC) 2004/108/CE
- Directiva RoHS 2011/65/UE
- Directiva RAEE (WEEE) 2012/19/UE

Y es conforme a las siguientes Normas Armonizadas Europeas:

In accordance with Harmonized European Norms:

- EN 60065:2002+A1:2006 +A11:2008+A2:2010 +A12:2011
Audio, video and similar electronic apparatus. Safety requirements.
- EN 55103-1:2009
Electromagnetic compatibility. Product family standard for audio, video, audio-visual and entertainment lighting control apparatus for professional use. Part 1:Emission.
- EN 55103-2:2009
Electromagnetic compatibility. Product family standard for audio, video, audio-visual and entertainment lighting control apparatus for professional use. Part 2:Immunity.

INTRODUCTION

For portable live sound applications, or fixed installations in almost any type of venue, the *Event Line Arrays* have been designed to provide exceptional sound, steadfast reliability and value beyond comparison.

Also, the *Event Line Arrays* incorporate high frequency waveguides designed with the same technology as the aero series. The *Event series* is composed of *event 208A* and *event 210A*, the monitor *event M210A* and the subwoofer *event 218A*, to provide a complete solution for all your *Events*.

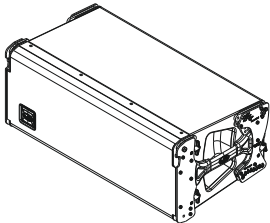

event 208A

- Three-way powered system
- Two 8" mid and bass loudspeakers
- Compression driver with titanium diaphragm
- Newly developed high frequency waveguide
- Optimized rigging and stacking system

The *event 208A* is a three-way powered system (3 channel Class D amplifier) with an 8" for bass and another 8" for mid range, and a compression driver, *M-75*, with 3" titanium diaphragm and 1.5" exit.

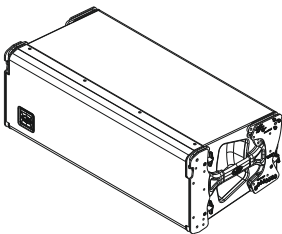

event 210A

- Three-way powered system
- Two 10" mid and bass loudspeakers
- Compression driver with titanium diaphragm
- Newly developed high frequency waveguide
- Optimized rigging and stacking system

The *event 210A* is three-way powered system (3 channel Class D amplifier) with a 10" for bass and another 10" for mid range, and a compression driver, *M-75*, with 3" titanium diaphragm and 1.5" exit.

Both include a three-way Class D amplifier that deliver 1200W peak power, and a comprehensive protection package, with peak and RMS limiters, to provide reliability and durability. With regards to DSP, the EZ-DSPTM system simplifies switching between short and medium throw, for accurate coverage.

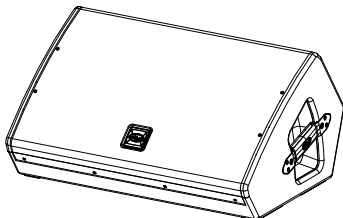

event M210A

- Powered 3-way stage monitor
- Two 10" mid and bass loudspeakers
- Compression driver with titanium diaphragm
- Newly developed high frequency waveguide
- Optimized rigging and stacking system

The *event M210A* is three-way powered system (3 channel Class D amplifier) with a 10" for bass and another 10" for mid range, and a compression driver, *M-60*, with 1.75" titanium diaphragm and 1" exit.

Both include a three-way Class D amplifier that deliver 1200W peak power, and a comprehensive protection package, with peak and RMS limiters, to provide reliability and durability. With regards to DSP, the EZ-DSPTM system simplifies switching between short and medium throw, for accurate coverage.

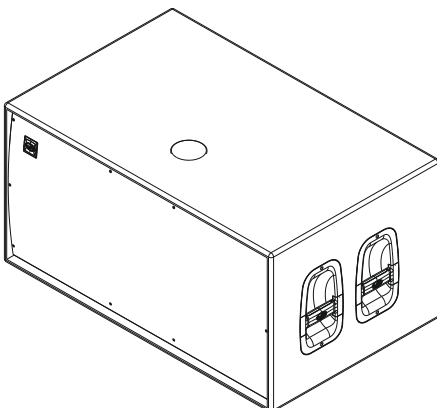

event 218A

- Powered subwoofer with high efficiency
- Two low frequency 18" cone loudspeakers
- Cabinet designed for horizontal stacking
- Top located pole mount socket (Ø 35mm)

The *event 218A* is the subwoofer needed for an optimum coupling with the *Event Line Arrays*. It incorporates two 18" loudspeakers with 4" coil and high efficiency.

The *event 218A* includes a Class D amplifier that delivers 3200W peak power, and a comprehensive protection package, with peak and RMS limiters, to provide reliability and durability.

All cabinets have a robust birch plywood construction, finished with ISO-flex paint for both good looks and a durable protective coating, and a rugged protective steel grille safeguards the D.A.S. components. Also, the systems incorporate protectors that protect the amplifiers from the sun and rain.

16 x event 210A
8 x event 218A

Medium - large flow 42800W peak power system

event
line array

CONFIGURATIONS (cont'd)

Note: You will find more examples on the web page: www.dasaudio.com.

System Accessories

- Rigging frames**
2 x AX-event210
- Speaker cabling:**
 - 12 x PowerCon link 0.5 m
 - 4 x PowerCon link 1 m
 - 14 x Signal link 0.5 m
 - 6 x Signal link 2 m
- Others**
DSP-2060A
- 4 x PL-event210S
- 4 x PL-event218S

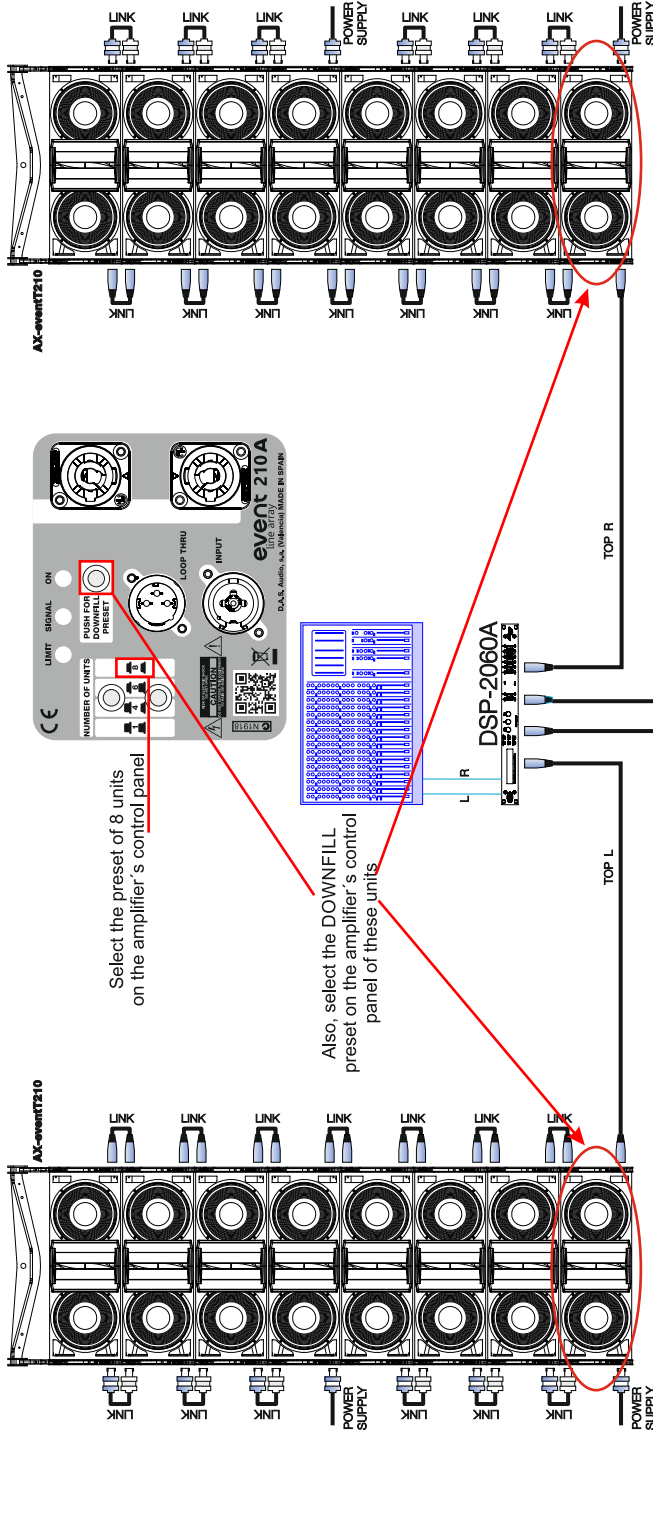

Select the preset of 8 units on the amplifier's control panel

Also, select the DOWNFILL preset on the amplifier's control panel of these units

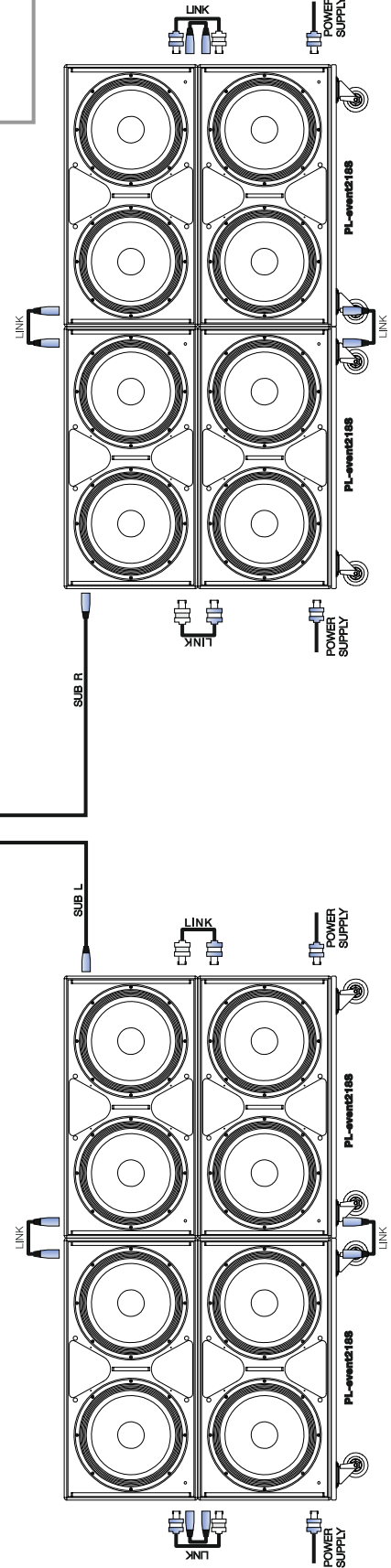

CONFIGURATIONS (cont'd)

Note: You will find more examples on the web page: www.dasaudio.com.

System Accessories

- Rigging frames**
2 x AX-event210
- Speaker cabling:**
 - 20 x PowerCon link 0,5 m
 - 8 x PowerCon link 2 m
 - 22 x Signal link 0,5 m
 - 10 x Signal link 2 m
- DSP-2060A**
- Others**
 - 6 x PL-event210S
 - 4 x PL-event218S

Large flown 64000W peak power system

24 x event 210A
12 x event 218A

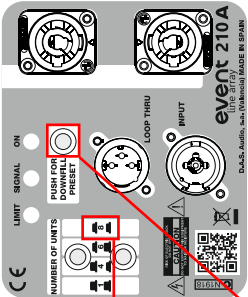
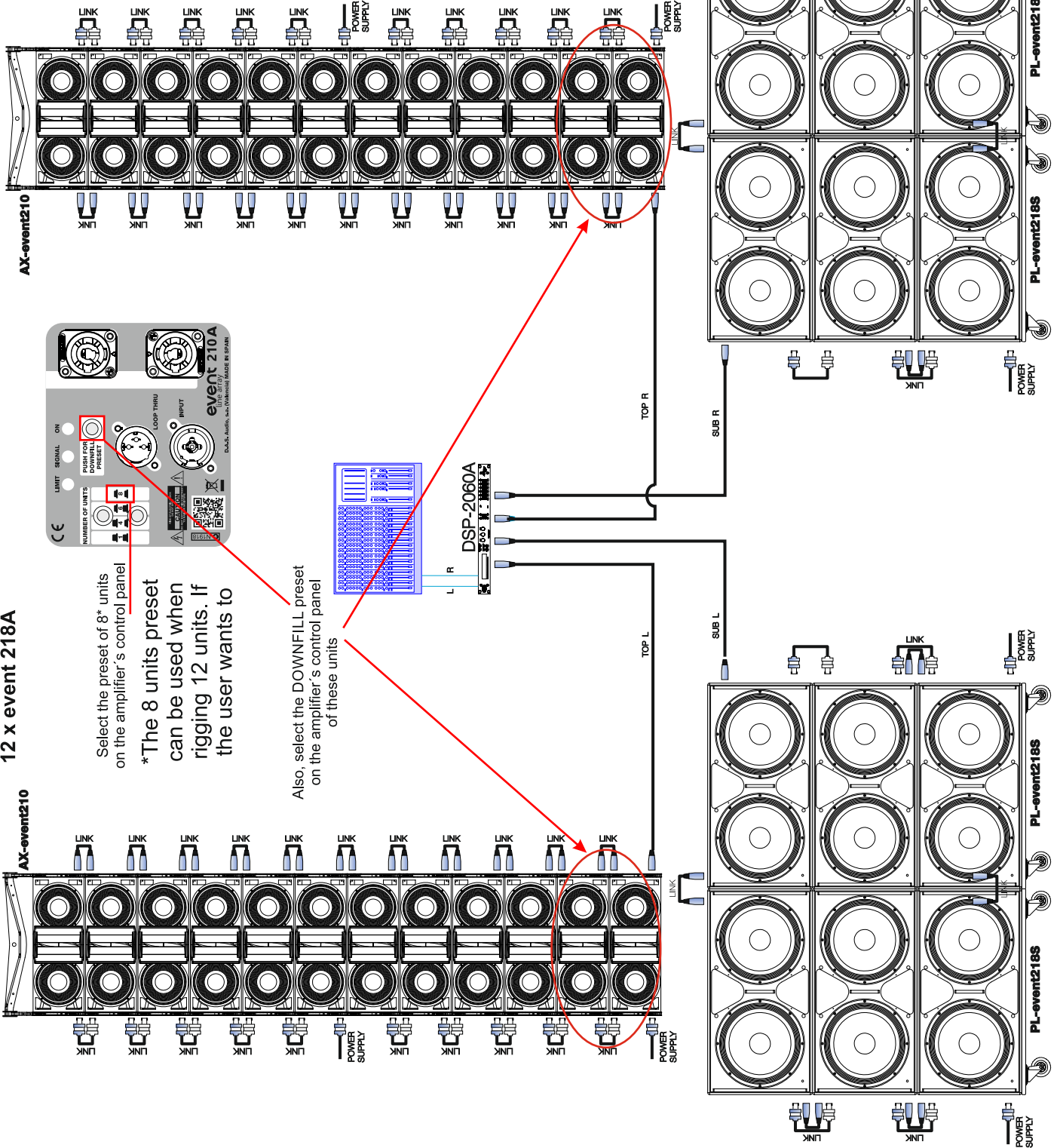

Select the preset of 8" units on the amplifier's control panel
*The 8 units preset can be used when rigging 12 units. If the user wants to

Also, select the DOWNFILL preset on the amplifier's control panel of these units

SPECIFICATIONS

Model	<i>event 208A</i>	<i>event 210A</i>	<i>event m210A</i>	<i>event 218A</i>
Nominal LF Power Amplifier	360 Wpeak - 180 Wcontinuous	360 Wpeak - 180 Wcontinuous	360 Wpeak - 180 Wcontinuous	3600 Wpeak - 1800 Wcontinuous
Nominal MF Power Amplifier	360 Wpeak - 180 Wcontinuous	360 Wpeak - 180 Wcontinuous	360 Wpeak - 180 Wcontinuous	---
Nominal HF Power Amplifier	360 Wpeak - 180 Wcontinuous	360 Wpeak - 180 Wcontinuous	360 Wpeak - 180 Wcontinuous	---
Input Type	Balanced Differential Line	Balanced Differential Line	Balanced Differential Line	Balanced Differential Line
Input Impedance	Line: 20 kohms	Line: 20 kohms	Line: 20 kohms	Line: 20 kohms
Sensitivity	Line: 6.2 V (+18 dBu)	Line: 6.2 V (+18 dBu)	Line: 6.2 V (+18 dBu)	Line: 1.95 V (+8 dBu)
Frequency Range (-10 dB)	75 Hz - 20 kHz	70 Hz - 20 kHz	70 Hz - 20 kHz	32 Hz - 125 Hz
Horizontal Coverage (-6 dB)	90° Nominal	90° Nominal	60° Nominal	---
Vertical Coverage	Splay Dependent	Splay Dependent	Vertical: 20° up/30° down	---
Rated Maximum Peak SPL at 1 m ⁽¹⁾	132 dB	134 dB	134 dB	140 dB
Transducers/Replacement Parts	LF: 1 x 8CM4/GM 8CM4 MF: 1 x 8CM4/GM 8CM4 HF: 1 x M-75/GM 75	LF: 1 x 10Mi4/GM 10Mi4 MF: 1 x 10Mi4/GM 10Mi4 HF: 1 x M-75/GM 75	LF: 10Mi4/GM 10Mi4 LMF: 10Mi4/GM 10Mi4 HF: M-60/GM M-60	LF: 2 x 18LX/GM 18LX
Enclosure Geometry	Trapezoidal 5°	Trapezoidal 5°	Wedge	Rectangular
Enclosure Material	Birch Plywood	Birch Plywood	Birch Plywood	Birch Plywood
Color/Finish	Black/ISO-flex Paint	Black/ISO-flex Paint	Black/ISO-flex Paint	Black/ISO-flex Paint
Rigging System	Integrated in box design	Integrated in box design	INPUT: Female XLR	INPUT: Female XLR
Connectors	INPUT: Female XLR LOOP THRU: Male XLR AC INPUT: powerCON AC OUTPUT: powerCON	INPUT: Female XLR LOOP THRU: Male XLR AC INPUT: powerCON AC OUTPUT: powerCON	LOOP THRU: Male XLR AC INPUT: powerCON AC OUTPUT: powerCON	LOOP THRU: Male XLR AC INPUT: powerCON AC OUTPUT: powerCON
AC Power Requirements	2.4 A, 115 V, 50/60 Hz 1.2 A, 230 V, 50/60 Hz	3.0 A, 115 V, 50/60 Hz 1.5 A, 230 V, 50/60 Hz	3.0 A, 115 V, 50/60 Hz 1.5 A, 230 V, 50/60 Hz	6.0 A, 115 V, 50/60 Hz 3.0 A, 230 V, 50/60 Hz
Dimensions (H x W x D)	27 x 67 x 36.6 cm 10.6 x 26.4 x 14.4 in	27 x 73 x 36.6 cm 10.6 x 28.7 x 14.4 in	32.8 x 64.5 x 45.8 cm 12.91 x 25.39 x 18.03 in	54 x 106 x 67 cm 21.3 x 41.7 x 26.4 in
Weight	30 kg (66 lb)	34 kg (74.8 lb)	24.5 kg (53.9 lb)	70 kg (154 lb)
Accessories	AX-event208 Rigging System AXS-event208 Stacking Base FUN-4-event208 Cover Pick-Up AX-event208 PL-event208S Steel Stacking Dolly	AX-event210 Rigging System AXS-event210 Stacking Base FUN-4-event210 Cover Pick-Up AX-event210 PL-event210S Steel Stacking Dolly		FUN-2-event218 Cover PL-event218S Stacking Dolly TRD-6 Pole Mount

Notes:
1. Maximum calculated Peak SPL based on sensitivity and RMS amplifier power.

D.A.S. Audio S.A. continuously strives to enhance its products through investigation and development. All specifications are subject to change without prior warning.

LINE DRAWINGS

ALL DIMENSIONS IN MILLIMETERS

event 208A

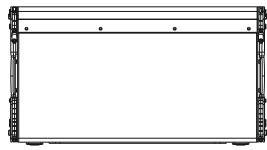

Top View

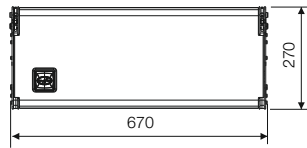

Front View

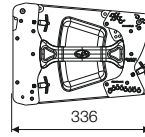

Right View

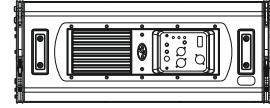

Rear View

event 210A

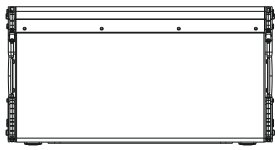

Bottom View

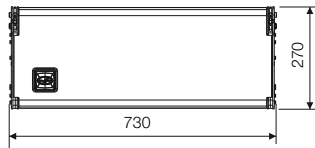

Front View

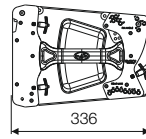

Right View

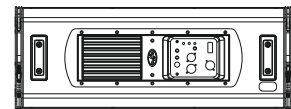

Rear View

event M210A

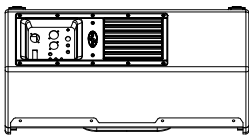

Bottom View

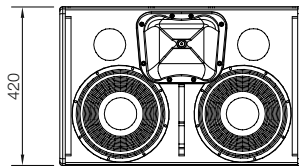

Front View

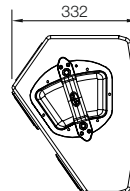

Left View

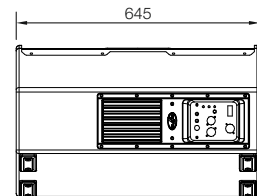

Rear View

event 218A

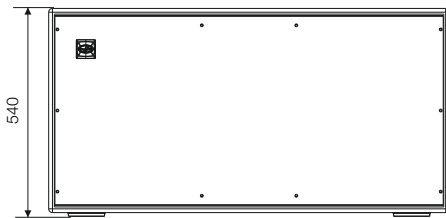

Front View

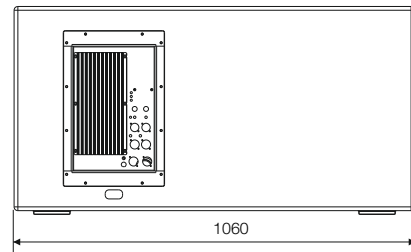

Rear View

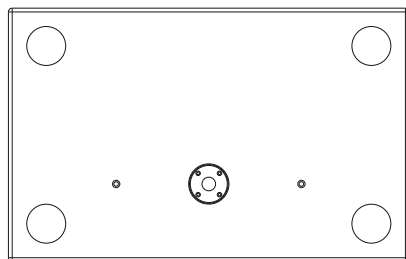

Top View

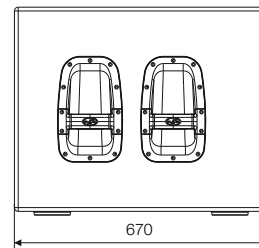

Right View

AMPLIFIER

Description

1) INPUT :

1/4" Jack+XLR combined socket-type input signal connector. This is a balanced connector just like the LOOP THRU connector with the following pin assignments:

- 1 or S =GND (ground)
- 2 or T =(+) Non inverted input
- 3 or R =(-) Inverted input

2) LOOP THRU (except *event218A*):

XLR-type output signal connector for connecting several units together and sending them all the same signal.

2) SATELLITE OUTPUT (only *event218A*):

A and B, XLR-type output signal connectors for connecting several units together and sending them all the same input signal or filtered signal (by using THRU/HPF).

3) LIMIT :

Red LED indicates amplifier saturation. Amplifier limiter indicator lights.

4) SIGNAL :

Green LED indicates signal presence.

5) ON :

Green LED indicates that the unit is ON.

6) LEVEL (only *event218A*):

Potentiometer for adjusting the unit level.

7) LOW-PASS (only *event218A*):

Button for adjusting the upper cut-off frequency for the subwoofer unit. We recommend a cut-off frequency of 100 Hz.

8) DOWN-FILL PRESET (only *event208A* and *event210A*):

Press the button to select the Down-Fill preset.

8) 90 Hz HPF ON/OFF (only *eventM210A*):

Press the button to select the HPF.

8) CARDIOID PRESET (only *event218A*):

Press the button to select the Cardioid preset.

9) NUMBER OF UNITS (except *event218A*):

Press the buttons to select the appropriate preset for this number of units (please, see the label).

10) AC INPUT :

PowerCon NAC3FCA mains connector (inserted, rotated and locked for ON). **Only use this equipment with an appropriate mains cord.**

11) AC OUTPUT :

PowerCon NAC3FCB connector for AC loop thru (see unit's label)). **Only use this equipment with an appropriate mains cord.**

12) POLARITY :

Switch for inverting the phase of the unit.

13) THRU/HPF (only *event 218A*):

'SATELLITE OUTPUT' selector to switch between full range signal or pass filter **with cut-off frequency of 100 Hz.**

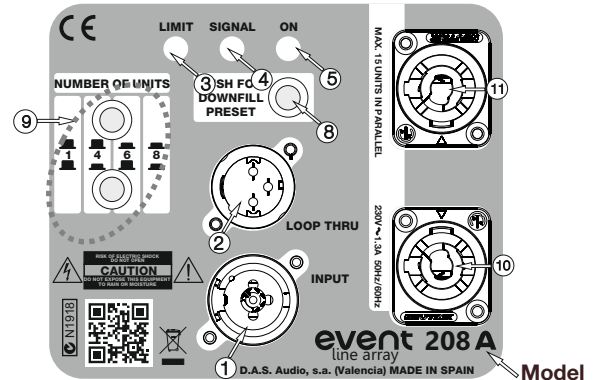

event 208A and event 210A amplifier label

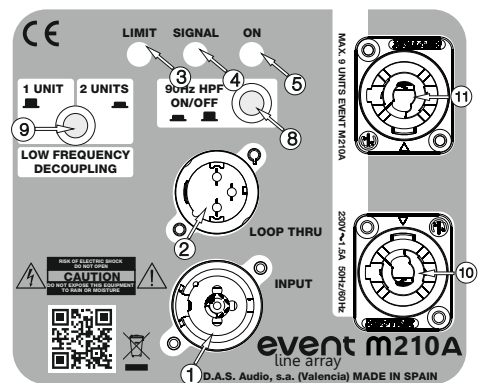

event M210A amplifier label

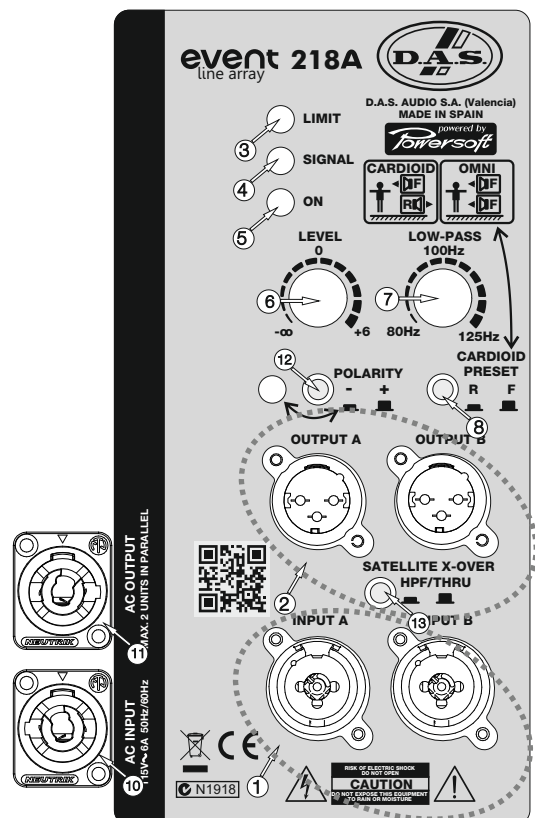

event 218A amplifier label

ON/OFF

A sound system should be switched on sequentially. Switch on the self-powered units last in your sound system (switch on the subwoofer before the mid-high system). Switch on the sound sources such as CD players or turntables, then the mixer, then the processors, and finally the self-powered unit. If you have several units, it is recommended that you switch them on sequentially one at a time.

Follow the inverse order when switching off, turning self-powered units off before any other element in the sound system.

Disconnect the device by removing the mains connector from the mains socket. The mains connector and mains socket must always be freely accessible and never covered or blocked in any way.

The models use a power cable equipped with a Neutrik PowerCon NC3FCA connector. Power can be daisy chained via the NC3FCB output connector (see details on product label).

IMPORTANT: Do not disconnect the unit while in use.

Ensure that the device is disconnected from the mains by observing that the ON LED is turned off. Please note that the ON LED can stay on for several seconds after the mains power has been disconnected.

Overload indicator

This device has an indicator (LIMIT LED) that lights when the signal is excessive.

The indicator should not be lit continuously. This distorts the signal (quickly fatiguing your ears) and may damage the speakers. Therefore, it is recommended that you never work with this LED on; at most it should blink only occasionally.

Equalisation

The unit does not need extreme settings of equalisation to produce quality sound. Avoid high levels of gain on the equalisers. Gain values above +3 dB on a console's EQ are not recommended.

Overheating

This equipment does not normally overheat during normal conditions of use. When overheating occurs, the unit protects itself. You should then find out why and if necessary contact an authorised dealer for technical assistance.

Normally it is enough just to let the unit cool down after you have corrected the problem so that the system functions properly again.

Keep grilles clean and dust-free.

Air circulates from the bottom to the top of the amplifier.

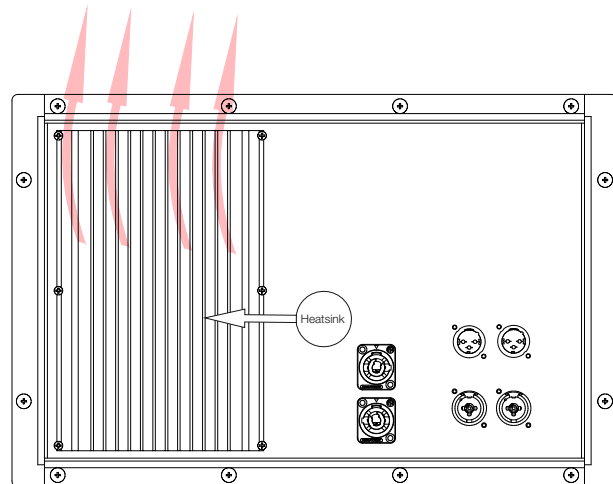

Heatsink of event 218A amplifier

Low mains voltage

If mains voltage falls below the shutdown voltage for the unit, it will stop playing. When acceptable levels are regained, the unit will switch back on automatically.

Therefore the current consumed by a 115V version is double the 230V version to achieve the same acoustic power level.

<i>Pink Noise Mains 230 Vrms</i>	1/3 Power
<i>event 208A</i>	1.3A
<i>event 210A</i>	1.5A
<i>event M210A</i>	1.5A
<i>event 218A</i>	2A

Troubleshooting

PROBLEM	CAUSE	SOLUTION
No sound from the unit. The SIGNAL LED does not light up.	<p>1 – The signal source is sending no signal.</p> <p>2 – Defective cable.</p> <p>3 - The amplifier has overheated.</p>	<p>1 – Check that the mixer or sound source is sending signal to the UNIT.</p> <p>2 – Check that the cable from the sound source to the UNIT is connected correctly. Replace the cable if defective.</p> <p>3 - Allow the unit to cool down for some minutes and it will function again. Check the main output level of the mixer or channel gains since the unit will have been functioning with excessive levels.</p>
Full power cannot be obtained. The LIMIT LED never lights up.	The signal source does not have a hot enough output.	If using a mixer, use the balanced output if available. Use a professional mixer with a hotter output.
Sound is distorted. The LIMIT LED is not on, or only lights up occasionally.	The mixer or signal source is distorting.	Turn mixer channel gains down. Check that none of your signal sources are distorting.
Sound is distorted and very loud and LIMIT LED lights up.	The system is overloaded and has reached maximum power.	Turn down the mixer's output.
Hum or buzz when a mixer is connected to the unit.	<p>1.– The console probably has unbalanced outputs. You may be using an incorrect un-balanced to balanced cable.</p> <p>2.– The mixer and the powered speaker are not plugged into the same mains outlet.</p> <p>3.– The audio signal cable is too long or too close to an AC cable</p>	<p>1.– Read the appendix of this manual to make a correct un-balanced to balanced cable.</p> <p>2.– Connect the mixer and the unit to the same mains outlet.</p> <p>3.– Use a cable that is as short as possible and/or move the audio signal cable away from mains cables.</p>
Hum or buzz when using lighting controls in the same building.	<p>1.– The audio signal cable is too long or too close to the lighting cable.</p> <p>2.– On a sound system with three-phase AC, the lighting equipment and the UNIT are connected to the same phase.</p>	<p>1.– Move the audio signal cable away from lighting cables. Try to find out at what point the noise is leaking into the system.</p> <p>2.– Connect the sound system to a different phase than the lights. You may need the help of an electrician.</p>
The ON LED does not light up when the mains connector is connected and the unit is switched to ON.	<p>1.– Bad or loose AC connection to the UNIT or the mains outlet.</p> <p>2 – Faulty AC cable.</p> <p>3 – Blown Fuse.</p> <p>4 - The mains voltage is out of range.</p>	<p>1.– Check your connections.</p> <p>2.– Check the cables, connectors and AC power with a suitable mains tester.</p> <p>3.- Replace the blown fuse for another of the same type and size.</p> <p>4.- If the multimeter determines that the mains voltage is out the range, you may need the assistance of an electrician to find an appropriate solution.</p>

Warning

Due to the numerous images needed to explain the *event series* array system setup, this manual can't offer all the necessary information to rig the **DAS Audio** system. In this document we only reflect the safety precautions and a summary of the elements.

To log in to the complete information, please consult **Rigging Manual**, which you will find on the web page **www.dasaudio.com**.

To perform any operations related to flying the system, read the present document first and act on the warnings and advice given. The goal is to allow the user to become familiar with the mechanical elements required to fly the acoustic system, as well as the safety measures to be taken during set-up and teardown.

Only experienced installers with adequate knowledge of the equipment and local safety regulations should fly speaker boxes. It is the user's responsibility to ensure that the systems to be flown (including flying accessories) comply with state and local regulations.

The working load limits in this manual are the results of tests by independent laboratories. It is the user's responsibility to follow and comply with safety factors, resistance values, periodical supervisions and warnings given in this manual. Product improvement by means of research and development is on going at **D.A.S. Audio** Specifications are subject to change without notice.

To this date, there is no international standard regarding the flying of acoustic systems. However, it is common practice to apply 5:1 safety factors for enclosures and static elements. For slings and elements exposed to material fatigue due to friction and load variation the following ratios must be met; 5:1 for steel cable slings; 4:1 for steel chain slings and 7:1 for polyester slings. Thus, an element with a breaking load limit of 1000 kg may be statically loaded with 200 kg (5:1 safety factor) and dynamically loaded with 142 kg (7:1 safety factor).

When a system is flying, the working load must be lower than the resistance of each individual flying point in the enclosure, as well as each box. Hanging hardware should be regularly inspected and suspect units replaced if in doubt. This is important to avoid injury and absolutely no risks should be taken in this respect. It is highly recommended that you implement an inspection and maintenance program on flying elements, including reports to be filled out by the personnel that will carry out the inspections. Local regulations may exist that, in case of accident, may require you to prevent evidence of inspection reports and corrective actions after defects were found.

Absolutely no risks should be taken with regards to public safety.

When flying enclosures from ceiling support structures, extreme care should be taken to assure the load bearing capabilities of the structures so that the installation is absolutely safe. Do not fly enclosures from unsafe structures. Consult a certified professional if needed. All flying accessories that are not supplied by D.A.S. Audio are the user's responsibility. Use at your own risk.

Accessories

The systems with *event series* are rigged (except *event 218A*) with the accessories *AX-EVENT208* (and *PickUp AX-EVENT208* if you need another lift motor), and *AX-EVENT208* (and *PickUp AX-EVENT208* if you need another lift motor). To stack, you will need the accessories *AXS-EVENT208* or *AXS-EVENT210*. The *event 218A* only can use to stack.

The platforms *PL-EVENT208S* and *PL-EVENT210S* allow the transport of up to four units (of *event 208A* and *event 210A*, respectively), but *PL-EVENT218S* only allows the transport of up to three units of *event 218A*.

Consult the **Rigging Manual** for more information about the accessories.

The metal parts are made of steel, covered with zinc and painting in black, with high resistency screws which act to reinforce the stacking and the rigging.

Next, we name the accessories with images.

Accessories

To complete this information, please consult **Rigging Manual**, and other documents, which you will find on the web page **www.dasaudio.com**.

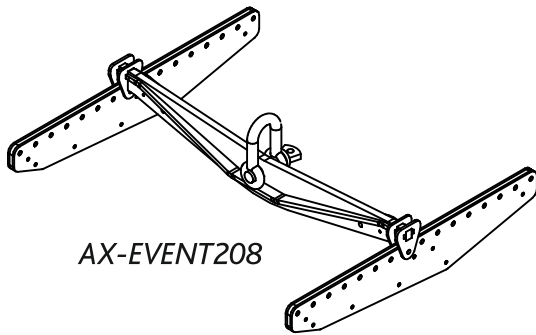

AX-EVENT208

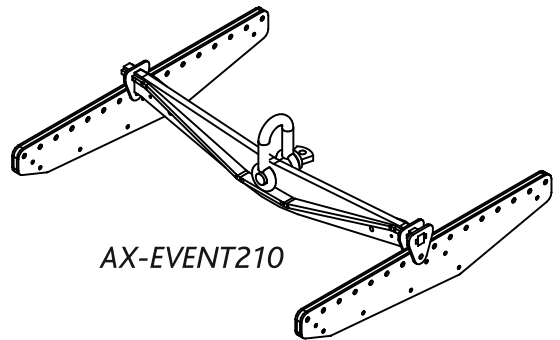

AX-EVENT210

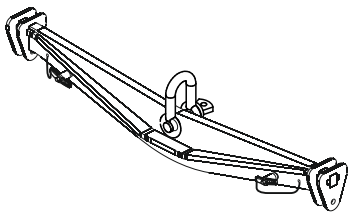

PICKUP AX-EVENT208

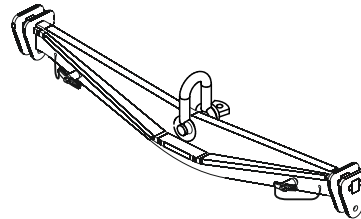

PICKUP AX-EVENT210

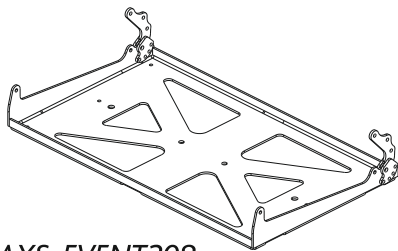

AXS-EVENT208

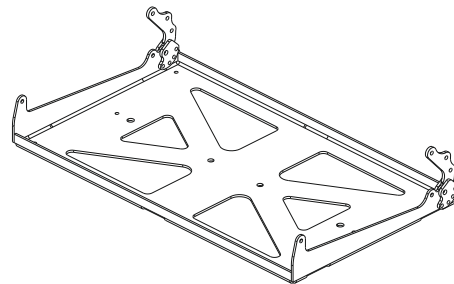

AXS-EVENT210

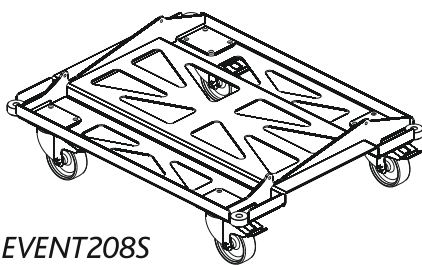

PL-EVENT208S

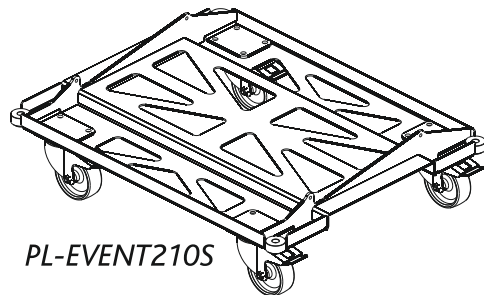

PL-EVENT210S

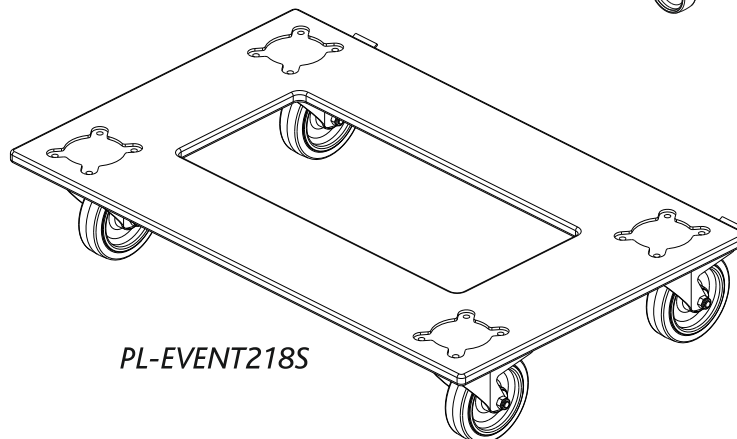

PL-EVENT218S

APPENDIX I: Line connections: unbalanced and balanced

There are two basic ways to transport an audio signal with microphone or line level:

Unbalanced line: Utilising a two conductor cable, it transports the signal as the voltage between them. Electromagnetic interference can get added to the signal as undesired noise. Connectors that carry unbalanced signals have two pins, such as RCA (Phono) and ¼" (6.35mm, often referred to as jack) mono. 3 pin connector such as XLR (Cannon) may also carry unbalanced signals if one of the pins is unused.

Balanced line: Utilising a three conductor cable, one of them acts as a shield against electromagnetic noise and is the ground conductor. The other two have the same voltage with respect to the ground conductor but with opposite signs. The noise that cannot be rejected by the shield affects both signal conductors in the same way. At the device's input the two signals get summed with opposite sign, so that noise is cancelled out while the programme signal doubles in level. Most professional audio devices use balanced inputs and outputs. Connectors that can carry balanced signal have three pins, such as XLR (Cannon) and ¼" (6.35mm) stereo.

The graphs that follow show the recommended connection with different types of connectors to balanced processor or amplifier inputs. The connectors on the left-hand side come from a signal source, and the ones on the right hand side go to the inputs of the processor or amplifier. Note that on the unbalanced connectors on the left-hand side, two terminals are joined inside the connector. If hum occurs with balanced connections, try disconnecting the sleeve (ground) on the input connector. Note that the illustrations show what should be connected to what, but that pin locations on an actual XLR connector are different. Also, pin 2 hot is assumed on XLR connectors.

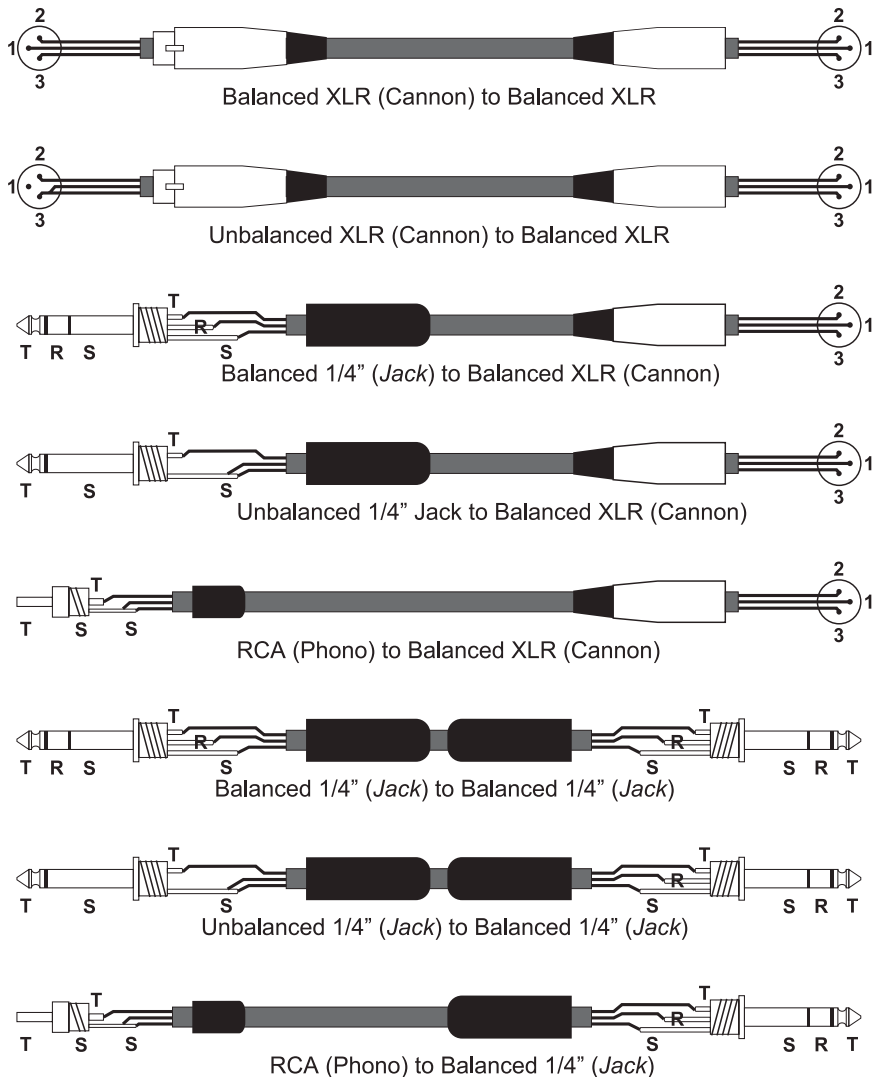

www.dasaudio.com



D.A.S. AUDIO, S.A.

C/ Islas Baleares, 24
46988 Fuente del Jarro
Valencia, SPAIN
Tel. 96 134 0525
Tel. Intl. +34 96 134 0860
Fax 96 134 0607
Fax Intl. +34 96 134 0607

D.A.S. AUDIO OF AMERICA, INC.

Sunset Palmetto Park
6816 NW 77th Court.
Miami, FL. 33166 - U.S.A.
TOLL FREE: 1-888DAS4USA
Tel. +1 305 436 0521
Fax +1 305 436 0528

D.A.S. AUDIO ASIA PTE. LTD.

25 Kaki Bukit Crescent #01-00/02-00
Kaki Bukit Techpark 1
Singapore 416256
Tel. +65 6742 0151
Fax +65 6742 0157